



OWNER'S MANUAL

AIR CONDITIONER

Read this owner's manual thoroughly before operating the appliance and keep it handy for reference at all times.

TYPE: WALL MOUNTED

EN	English	IT	Italiano	ES	Español	FR	Français	DE	Deutsch
EL	Ελληνικά	PT	Português	NL	Nederlands	PL	Polski	HU	Magyar
BG	Български	HR	Hrvatski						



MFL70270101
Rev.02_013018

www.lg.com

Copyright © 2017 - 2018 LG Electronics Inc. All Rights Reserved.

TABLE OF CONTENTS

This manual may contain images or content different from the model you purchased.
This manual is subject to revision by the manufacturer.

SAFETY INSTRUCTIONS	3
IMPORTANT SAFETY INSTRUCTIONS	3
Notes for Operation	8
Specifications	8
OPERATION	9
Parts and Functions.....	9
Wireless Remote Control.....	10
Restarting the Air Conditioner Automatically	14
Using the Mode Function.....	14
Using the Jet Mode Function.....	16
Using the Fan Speed Function	17
Using the Air Flow Direction Function.....	17
Setting the On/Off Timer.....	18
Using the Sleep Function	19
Using the Light Off Function	19
Using the Comfort Air Function.....	19
Using the Energy Control Function.....	20
Using Special Functions	21
SMART FUNCTIONS	23
Using LG SmartThinQ Application.....	23
MAINTENANCE.....	26
Clean the Air Filter	27
Clean the 3M Filter	27
Clean the Ionizer	28
TROUBLESHOOTING	29

The following safety guidelines are intended to prevent unforeseen risks or damage from unsafe or incorrect operation of the appliance. The guidelines are separated into 'WARNING' and 'CAUTION' as described below.

 This symbol is displayed to indicate matters and operations that can cause risk. Read the part with this symbol carefully and follow the instructions in order to avoid risk.

 **WARNING**

This indicates that the failure to follow the instructions can cause serious injury or death.

 **CAUTION**

This indicates that the failure to follow the instructions can cause the minor injury or damage to the product.

IMPORTANT SAFETY INSTRUCTIONS

 **WARNING**

To reduce the risk of explosion, fire, death, electric shock, injury or scalding to persons when using this product, follow basic precautions, including the following:

Children in the Household

This appliance is not intended for use by persons (including children) with reduced physical, sensory or mental capabilities, or lack of experience and knowledge, unless they have been given supervision or instruction concerning use of the appliance by a person responsible for their safety. Children should be supervised to ensure that they do not play with the appliance.

For use in Europe:

This appliance can be used by children aged from 8 years and above and persons with reduced physical, sensory or mental capabilities or lack of experience and knowledge if they have been given supervision or instruction concerning use of the appliance in a safe way and understand the hazards involved. Children shall not play with the appliance. Cleaning and user maintenance shall not be made by children without supervision.

Installation

- Do not install the air conditioner on an unstable surface or in a place where there is danger of it falling.
- Contact an authorized service center when installing or relocating the air conditioner.
- Install the panel and the cover of the control box safely.
- Do not install the air conditioner in a place where flammable liquids or gases such as gasoline, propane, paint thinner, etc., are stored.
- Make sure that the pipe and the power cable connecting the indoor and outdoor units are not pulled too tight when installing the air conditioner.
- Use standard circuit breaker and fuse that conform to the rating of the air conditioner.
- Do not input air or gas into the system except with the specific refrigerant.
- Use non-flammable gas (nitrogen) to check for leak and to purge air; using compressed air or flammable gas may cause fire or explosion.
- The indoor/outdoor wiring connections must be secured tightly, and the cable should be routed properly so that there is no force pulling the cable from the connection terminals. Improper or loose connections can cause heat generation or fire.
- Install dedicated electric outlet and circuit breaker before using the air conditioner.
- Do not connect the ground wire to a gas pipe, a lightning rod, or a telephone ground wire.

Operation

- Be sure to use only those parts listed in the service parts list. Never attempt to modify the equipment.
- Make sure that children do not climb on or hit the outdoor unit.
- Dispose of the batteries in a place where there is no danger of fire.
- Use only the refrigerant specified on the air conditioner label.
- Cut off the power supply if there is any noise, smell, or smoke coming from the air conditioner.
- Do not leave flammable substances such as gasoline, benzene, or thinner near the air conditioner.
- Contact an authorized service center when the air conditioner is submerged by flood waters.

- Do not use the air conditioner for an extended period of time in a small place without proper ventilation.
- In the event of a gas leak (such as Freon, propane gas, LP gas, etc.) ventilate sufficiently before using the air conditioner again.
- To clean the interior, contact an authorized service center or dealer. Using harsh detergents may cause corrosion or damage to the unit.
- Be sure to ventilate sufficiently when the air conditioner and a heating appliance such as a heater are used simultaneously.
- Do not block the inlet or outlet of air flow.
- Do not insert hands or other objects through the air inlet or outlet while the air conditioner is operating.
- Make sure that the power cable is neither dirty, loose, nor broken.
- Never touch, operate, or repair the air conditioner with wet hands.
- Do not place any objects on the power cable.
- Do not place a heater or other heating appliances near the power cable.
- Do not modify or extend the power cable. Scratches or peeling insulation on the power cables may result in fire or electric shock, and should be replaced.
- Cut off the power supply immediately in the event of a blackout or a thunderstorm.
- Take care to ensure that power cable could not be pulled out or damaged during operation.
- Do not touch refrigerant pipe, water pipe and any internal parts while the unit is operating or immediately after operation.

Maintenance

- Before cleaning or performing maintenance, disconnect the power supply and wait until the fan stops.
- Do not clean the appliance by spraying water directly onto the product.

Technical Safety

- Installation or repairs made by unauthorized persons can pose hazards to you and others.
- The information contained in the manual is intended for use by a qualified service technician who is familiar with the safety procedures and equipped with the proper tools and test instruments.
- Failure to read and follow all instructions in this manual can result in equipment malfunction, property damage, personal injury and/or death.

- The appliance shall be installed in accordance with national wiring regulations.
- When the power cord is to be replaced, the replacement work shall be performed by authorized personnel using only genuine replacement parts.
- This appliance must be properly grounded to minimize risk of electric shock.
- Do not cut or remove the grounding prong from the power plug.
- Attaching the earth wire to the power outlet cover screw does not ground the appliance unless the cover screw is metal, uninsulated, and the power outlet is grounded through house wiring.
- If you have any doubt whether the air conditioner is properly grounded, have the power outlet and circuit checked by a qualified electrician.
- The refrigerant and insulation blowing gas used in the appliance require special disposal procedures. Consult a service agent or a similarly qualified person before disposing of them.
- If the supply cord is damaged, it must be replaced by the manufacturer or its service agents or similarly qualified person in order to avoid a hazard.

CAUTION

To reduce the risk of minor injury to persons, malfunction, or damage to the product or property when using this product, follow basic precautions, including the following:

Installation

- Do not install the air conditioner in an area where it is directly exposed to sea wind (salt spray).
- Install the drain hose properly for the smooth drainage of water condensation.
- Exercise caution when unpacking or installing the air conditioner.
- Do not touch the leaking refrigerant during installation or repair.
- Transport the air conditioner with two or more people or use a forklift.
- Install the outdoor unit such that it is protected from direct sunlight. Do not place the indoor unit in a place where it is directly exposed to sunlight via the windows.
- Safely dispose of packing materials such as screws, nails or batteries using proper packaging after installation or repair.

- Install the air conditioner in a place where the noise from the outdoor unit or the exhaust fumes will not inconvenience the neighbors. Failure to do so may result in conflict with the neighbors.

Operation

- Remove the batteries if the remote control is not to be used for an extended period of time.
- Make sure that the filter is installed before operating the air conditioner.
- Be sure to check if there is a refrigerant leak after installing or repairing the air conditioner.
- Do not place any object on the air conditioner.
- Never mix different types of batteries, or old and new batteries for the remote control.
- Do not let the air conditioner run for a long time when humidity is very high or when a door or a window has been left open.
- Stop using the remote control if there is a fluid leak in the battery. If your clothes or skin are exposed to the leaking battery fluid, wash off with clean water.
- Do not expose people, animals, or plants to the cold or hot wind from the air conditioner for extended periods of time.
- If the leaking battery fluid has been swallowed, rinse the inside of the mouth thoroughly and consult a doctor.
- Do not drink the water drained from the air conditioner.
- Do not use the product for special purposes, such as preserving foods, works of art, and etc. It is an air conditioner for consumer purposes, not a precision refrigeration system. There is risk of damage or loss of property.
- Do not recharge or disassemble the batteries.

Maintenance

- Never touch the metal parts of the air conditioner when removing the air filter.
- Use a sturdy stool or ladder when cleaning, maintaining, or repairing the air conditioner at a height.
- Never use strong cleaning agents or solvents when cleaning the air conditioner or spray water. Use a smooth cloth.

Notes for Operation

Suggestion for Energy Saving

- Do not over-cool the space. This may be harmful for your health and may consume more electricity.
- Block sunlight with blinds or curtains while you are operating the air conditioner.
- Keep doors or windows closed tightly while you are operating the air conditioner.
- Adjust the direction of the air flow vertically or horizontally to circulate indoor air.
- Speed up the fan to cool or warm indoor air quickly, within a short period of time.
- Open windows regularly for ventilation. The indoor air quality may deteriorate if the air conditioner is used for long durations.
- Clean the air filter once every 2 weeks. Dust and impurities collected in the air filter may block the air flow or reduce the unit performance.

Specifications

Set (Indoor / Outdoor)			Unit	S4-W09M2MZA	S4-W12M2MZA
				(S4NW09M2MZA/ S4UW09M2MZA)	(S4NW12M2MZA/ S4UW12M2MZA)
Capacity	Cooling	Rated	kW	2.50	3.50
	Heating	Rated	kW	3.20	4.00
Power Input	Cooling	Rated	W	490	833
	Heating	Rated	W	593	785
Power Supply			Ø, V, Hz	1, 220-240, 50	1, 220-240, 50
Indoor	Sound Pressure Level	Cooling, H / M / L / SL	dB(A)	42 / 37 / 29 / 19	42 / 37 / 29 / 19
		Heating, H / M / L	dB(A)	42 / 37 / 29	42 / 37 / 29
	Weight	Net	kg	11.0	11.0
Outdoor	Sound Pressure Level	Cooling, Rated	dB(A)	48	48
		Heating, Rated	dB(A)	50	50
	Weight	Net	kg	42.5	42.5
Operation Range		Cooling	°C DB	-10 ~ 48	-10 ~ 48
		Heating	°C DB	-25 ~ 24	-25 ~ 24
Refrigerant		Type	-	R410A	R410A
		Pre Charge	g	1150	1150

Parts and Functions

Indoor Unit

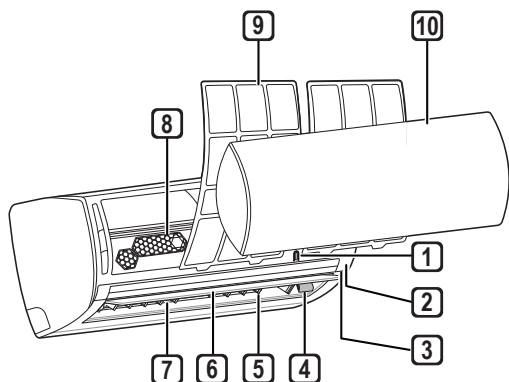

- 1 On/Off Button
- 2 Signal Receiver
- 3 Operation Lamp
- 4 Ionizer
- 5 Air Deflector (Vertical Louver)
- 6 Air Deflector (Horizontal Vane)
- 7 Air Outlet
- 8 3M Filter
- 9 Air Filter
- 10 Front Panel

Outdoor Unit

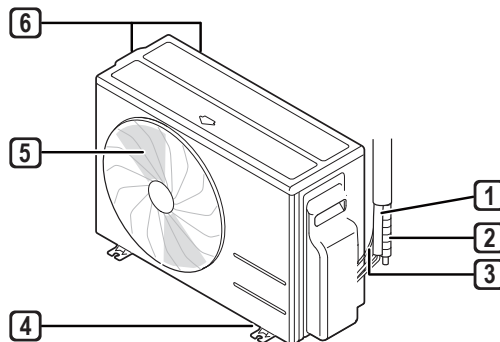

- 1 Coolant Piping
- 2 Drain Hose
- 3 Connection Wire
- 4 Base Plate
- 5 Air Outlet Vents
- 6 Air Intake Vents

Indoor Display Screen

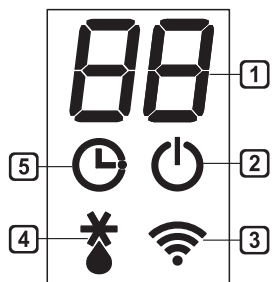

- 1 Desired temperature / Room temperature
- 2 On/Off
- 3 Wi-Fi
- 4 Defrosting / Preheating
- 5 Timer

Wireless Remote Control

Inserting Batteries

If the display screen of the remote control begins to fade, replace the batteries. Insert AAA (1.5 V) batteries before using the remote control.

- 1 Remove the battery cover.

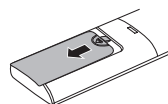

- 2 Insert the new batteries and make sure that the + and - terminals of the batteries are installed correctly.

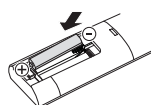

Installing the Remote Control Holder

To protect the remote control, install the holder where there is no direct sunlight.

- 1 Choose a safe and easily accessible location.
- 2 Fix the holder by fastening 2 screws firmly with a screwdriver.

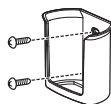

Operating Method

Point the remote control towards the signal receiver at the right side of the air conditioner to operate it.

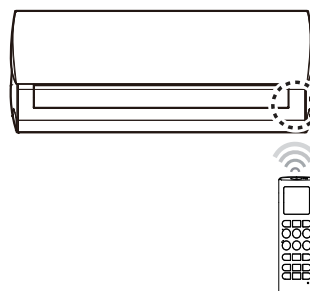

NOTE

- The remote control may operate other electronic devices if it is directed towards them. Make sure to point the remote control towards the air conditioner signal receiver.
- For proper operation, use a soft cloth to clean the signal transmitter and receiver.
- In case of a function not provided in the product, no buzzer sound occurs from the product when a button for such function on the remote control is pressed except for Air Flow Direction (SWING), Air Purification function.

Setting the Current Time

- 1 Insert batteries.
 - The icon below blinks at the bottom of the display screen.



- 2 Press  or  button to select the minutes.
- 3 Press **SET/CANCEL** button to finish.

NOTE

- The On/Off Timer is available after setting the current time.

Using the °C/°F Conversion Function

This function changes unit between °C and °F

- Press and hold  button about 5 seconds.

Operating the Air Conditioner without the Remote Control

You can use the **ON/OFF** button of the indoor unit to operate the air conditioner when the remote control is unavailable.

- 1 Open the front cover.
 - Lift up both sides of the cover slightly.

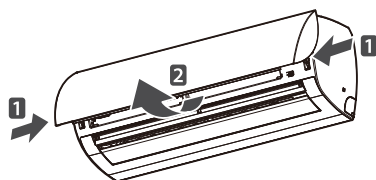

- 2 Press the **ON/OFF** button.

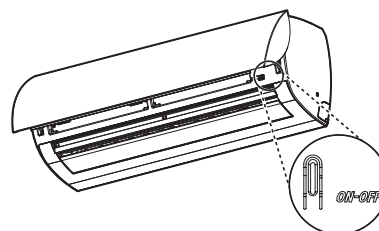

- 3 Close the front panel as soon as you press the **ON/OFF** button.
 - Lift down both sides of the panel slightly.

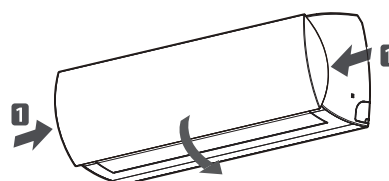

- For cooling and heating models, the operation mode changes, depending on the room temperature.

Room Temp.	Set Temp.	Operation Mode
Below 21°C	24°C	Heating Operation
Above 21°C and below 24°C	23°C	Dehumidifying Operation
Above 24°C	22°C	Cooling Operation

- For cooling-only models, the temperature is set to 22 °C

Using Wireless Remote Control

You can operate the air conditioner more conveniently with the remote control.

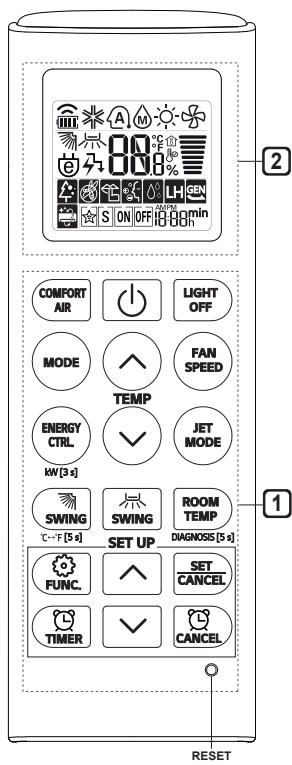

1 Button	2 Display Screen	Description
	-	To turn on/off the air conditioner.
 TEMP 	88 °C	To adjust the desired room temperature in cooling, heating or auto changeover mode.
MODE		To select the cooling mode. (P.14)
		To select the heating mode. (P.15)
		To select the dehumidification mode. (P.15)
		To select the fan mode. (P.15)
		To select the auto changeover/auto operation mode. (P.16)
JET MODE	Po	To change room temperature quickly. (P.16)
FAN SPEED		To adjust the fan speed. (P.17)
		To adjust the air flow direction vertically or horizontally. (P.17)
	ON OFF	To turn on/off air conditioner automatically at desired time. (P.18)
SET/CANCEL	-	To set/cancel the special functions and timer.
	-	To cancel the timer settings. (P.18)
	-	To adjust time.

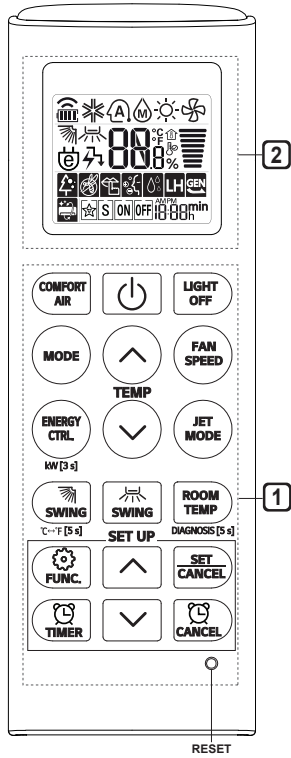

1 Button	2 Display Screen	Description
LIGHT OFF	-	To set the brightness of the display on the indoor unit. (P.19)
ROOM TEMP		To display the room temperature.
°C↔°F [5 s]		To change unit between °C and °F (P.11)
COMFORT AIR		To adjust the air flow to deflect wind. (P.19)
ENERGY CTRL		To bring the effect of the power saving. (P.20)
DIAGNOSIS [5 s]	-	To conveniently check maintenance information of a product. (P.25)
		To purify the air by removing particles that enters the indoor unit. (P.21)
		To reduce noise from outdoor units. (P.22)
		To maintain a minimum room temperature and prevent objects in the room from freezing. (P.22)
		To remove moisture generated inside the indoor unit. (P.22)
RESET	-	To initialize the remote control settings.

NOTE

- Press the **SET/CANCEL** button to operate the selected **FUNC.**

Restarting the Air Conditioner Automatically

When the air conditioner is turned on again after a power failure, this function restores the previous settings.

Disabling Auto Restart

- 1 Open the front cover.
 - Lift up both sides of the cover slightly.

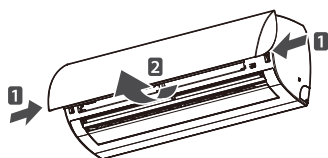

- 2 Press the **ON/OFF** button and hold it for 6 seconds, then the unit will beep twice and the lamp will blink twice 4 times.
 - To re-enable the function, press the **ON/OFF** button and hold it for 6 seconds. The unit will beep twice and the lamp will blink 4 times.

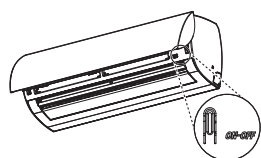

NOTE

- The feature may be changed according to the type of model.
- If you press and hold the **ON/OFF** button for 3 – 5 seconds, instead of 6 seconds, the unit will switch to the test operation. In the test operation, the unit blows out strong cooling air for 18 minutes and then returns to factory default settings.

Using the Mode Function

This function allows you to select the desired function.

Cooling & Heating Model

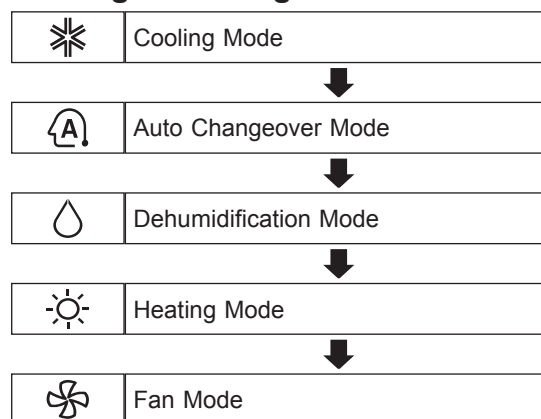

Cooling Mode

- 1 Turn the appliance on.
- 2 Press **MODE** button repeatedly to select the Cooling Mode.
 - is displayed on the display screen.

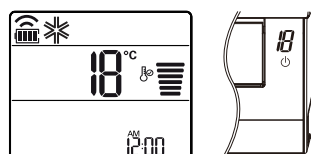

- 3 Press or button to set the desired temperature.

Heating Mode

- 1 Turn the appliance on.
- 2 Press **MODE** button repeatedly to select the Heating Mode.
 -  is displayed on the display screen.

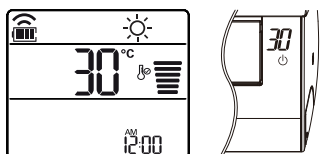

- 3 Press  or  button to set the desired temperature.

NOTE

-  will be displayed on the indoor unit when defrosting is operating.

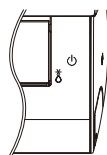

- Furthermore, this indication will be displayed on the indoor unit:
 - When preheating is operating.
 - When the room temperature has been reached to the set temperature.

Dehumidification Mode

This mode removes excess moisture from a highly humid environment or during the rainy season, in order to prevent mildew from setting in. This mode adjusts the room temperature and the fan speed automatically to maintain the optimal level of humidity.

- 1 Turn the appliance on.
- 2 Press **MODE** button repeatedly to select the Dehumidification Mode.
 -  is displayed on the display screen.

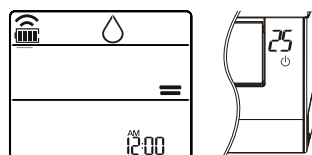

NOTE

- In this mode you cannot adjust the room temperature, it is adjusted automatically.
- The room temperature is not displayed on the remote control.

Fan Mode

This mode only circulates the indoor air without changing the room temperature.

- 1 Turn the appliance on.
- 2 Press **MODE** button repeatedly to select the Fan Mode.
 -  is displayed on the display screen.

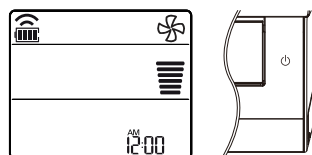

- 3 Press **FAN SPEED** button to adjust the fan speed.

Auto Changeover Mode

This mode changes the mode automatically to maintain the set temperature at ± 2 °C

- 1 Turn the appliance on.
- 2 Press **MODE** button repeatedly to select the Auto Changeover Mode.
 - **A** is displayed on the display screen.

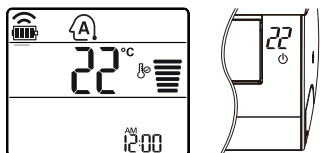

- 3 Press **▲** or **▼** button to set the desired temperature.
- 4 Press **FAN SPEED** button to adjust the fan speed.

Using the Jet Mode Function

Changing Room Temperature Quickly

This function allows you to cool indoor air quickly during the summer or warm it quickly during winter.

- Cooling & Heating model : The Jet Mode function is available with Cooling, Heating and Dehumidification Mode.

- 1 Turn the appliance on.
- 2 Press **MODE** button repeatedly to select the desired mode.
- 3 Press **JET MODE** button.
 - **Po** is displayed on the display screen.

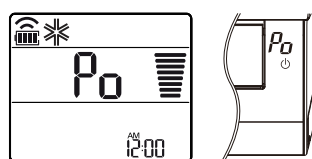





NOTE

- In Jet Cooling Mode, strong air blows out for 30 minutes.
- After 30 minutes later, setting temperature is maintaining 18 °C
If you want to change the temperature, Press **▲** or **▼** button to set the desired temperature.
- In Jet Heating Mode, strong air blows out for 30 minutes.
- After 30 minutes later, setting temperature is maintaining 30 °C
If you want to change the temperature, Press **▲** or **▼** button to set the desired temperature.

Using the Fan Speed Function

Adjusting the Fan Speed

- Press **FAN SPEED** button repeatedly to adjust the fan speed.

Display Screen	Speed
	High
	Medium - High
	Medium
	Medium - Low
	Low
-	Natural Wind

NOTE

- The fan speed of Natural Wind adjusts automatically.





- The fan speed icons are displayed on some indoor units.

F1 → F2 → F3 → F4 → F5



- Indoor unit display is displayed only 5 seconds and return to the setting temperature on some models.

Using the Air Flow Direction Function

This function adjusts the direction of the air flow vertically (horizontally).

- Press   button repeatedly and select the desired direction.
- Select  to adjust the direction of the air flow automatically.

NOTE

- Adjusting the air flow direction horizontally may not be supported, depending on the model.
- Adjusting the air deflector arbitrarily may cause product failure.
- If you restart the air conditioner, it starts to operate with the previously set direction of air flow, so the air deflector may not match the icon displayed on the remote control. When this occurs, press  or  button to adjust the direction of the air flow again.
- This function may operate differently from the remote control display.

Setting the On/Off Timer



This function sets the air conditioner to turn on/off automatically at desired time.

On/Off Timer can be set together.

Setting the On Timer

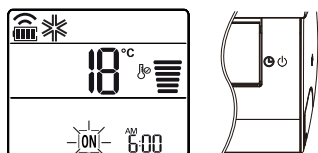
- 1 Press  button repeatedly.
 - The icon below blinks at the bottom of the display screen.



- 2 Press  or  button to select the minutes.
- 3 Press **SET/CANCEL** button to finish.
 - After setting the timer, current time and  icon are displayed on the display screen indicating that the desired time is set.

Canceling the On Timer

- 1 Press  button repeatedly.
 - The icon below blinks at the bottom of the display screen.

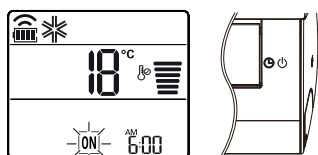



- 2 Press **SET/CANCEL** button to cancel the setting.

Setting the Off Timer

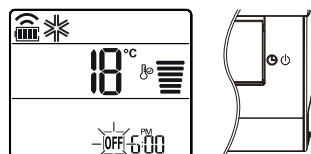
- 1 Press  button repeatedly.
 - The icon below blinks at the bottom of the display screen.



- 2 Press  or  button to select the minutes.
- 3 Press **SET/CANCEL** button to finish.
 - After setting the timer, current time and  icon are displayed on the display screen indicating that the desired time is set.

NOTE

- This function is disabled when you set Simple Timer.

Canceling the Off Timer

- 1 Press  button repeatedly.
 - The icon below blinks at the bottom of the display screen.

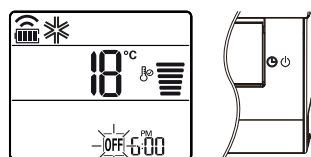

- 2 Press **SET/CANCEL** button to cancel the setting.

Canceling the Timer Setting



- Press  button to cancel all timer settings.

Using the Sleep Function

This function turns off the air conditioner automatically when you go to sleep.

- 1 Turn the appliance on.
- 2 Press  button repeatedly.
 - The icon below blinks at the bottom of the display screen.



- 3 Press  or  button to select the hour (up to 7 hours).
- 4 Press **SET/CANCEL** button to finish.
 -  is displayed on the display screen.

NOTE

-  is displayed on some indoor units.
- Indoor unit display is displayed from 1H to 7H which is displayed only 5 seconds and then return to the setting temperature.
- In the Cooling and Dehumidification Mode, the temperature increases by 1 °C after 30 minutes and additional 1 °C after another 30 minutes for a more comfortable sleep.
- The temperature increases up to 2 °C from the preset temperature.
- Although the remark for fan speed on the display screen may be changed, the fan speed is adjusted automatically.

Using the Light Off Function

Display Screen Brightness

You can set the brightness of the indoor unit display screen.

- Press **LIGHT OFF** button.



NOTE

- Turn on/off the Display screen.

Using the Comfort Air Function



Comfort Vane Operation

This function conveniently sets the vane to a preset position to deflect the supply air away from blowing directly onto the occupants in the room.

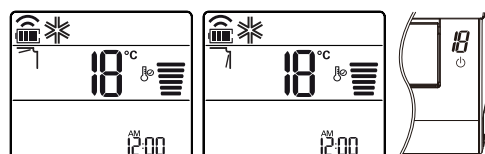
- 1 Turn the appliance on.
- 2 Press **COMFORT AIR** button repeatedly and select the desired direction.
 -  or  is displayed on the display screen.



NOTE

-  or  is displayed on some indoor units.
- This function is disabled when you press **MODE** or **JET MODE** button.
- This function is disabled and auto swing of vertical direction is set up when you press  button.
- When this function is off, the horizontal vane operates automatically depending on the set mode.

Using the Energy Control Function

- 1 Turn the appliance on.
- 2 Press **ENERGY CTRL** button.
 - Press **ENERGY CTRL** button repeatedly to select each step.

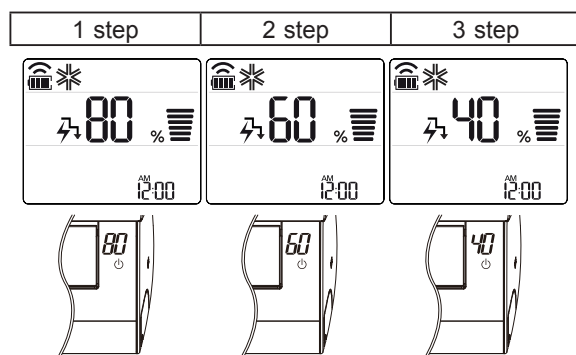





NOTE

- 1 step : The power Input is decreased by 20 % compared to rated power input.
– 80 % is displayed on the display screen.
- 2 step : The power Input is decreased by 40 % compared to rated power input.
– 60 % is displayed on the display screen.
- 3 step : The power Input is decreased by 60 % compared to rated power input.
– 40 % is displayed on the display screen.
- This function is available with Cooling Mode.
- Capacity may decrease when Energy Control mode is selected.
- Desired temperature is displayed about 5 seconds if you press **FAN SPEED**, \uparrow or \downarrow button.
- Room temperature is displayed about 5 seconds if you press **ROOM TEMP** button.

Using Special Functions

- 1 Turn the appliance on.
- 2 Press **FUNC** button repeatedly to select the desired function.
- 3 Press **SET/CANCEL** button to finish.



Display Screen	Description
	To purify the air by removing particles that enters the indoor unit. (P.21)
	To reduce noise from outdoor units. (P.22)
	To maintain a minimum room temperature and prevent objects in the room from freezing. (P.22)
	To remove moisture generated inside the indoor unit. (P.22)

NOTE

- Some functions may not be supported, depending on the model.
- Some functions may operate differently from the remote control display.

Canceling Special Functions

- 1 Press **FUNC** button repeatedly to select the desired function.
- 2 Press **SET/CANCEL** button to cancel the function.

Using the Air Purification Function

These functions supply clean and fresh air by ion particles and the filter.

Function	Display	Description
Ionizer		Ion particles from ionizer sterilize the aerial bacteria and other harmful substances.
Plasma		It removes microscopic contaminants from the intake air completely to supply clean and fresh air.

NOTE

- You can use this function without turning the air conditioner on.
- Both the plasma lamp and the cooling lamp light up while Smoke Away/Plasma is in operation on some models.
- Do not touch ionizer during operation.
- This function may operate differently from the remote control display.

Using the Silent Function

This function prevents potential claims by neighbors, reducing noise from outdoor units.

-  is displayed on the display screen.

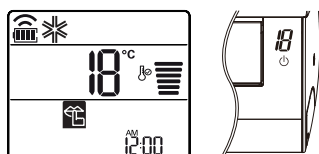

NOTE

- This function is disabled when you press **MODE** or **ENERGY CTRL** or **JET MODE** button.
- This function is available with Cooling, Heating, Auto Changeover, Auto Operation Mode.



Using the Low Heating Function

This function operates the heating system to maintain a minimum room temperature and prevent objects in the room from freezing where there is no permanent resident, such as a vacation.

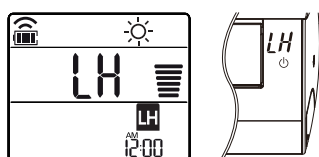
- , **LH** are displayed on the display screen.



NOTE

- This function is available with Heating Mode.
- During LH operation, when you press buttons such as , , **MODE**, **FAN SPEED**, and then return to Heating Mode, 30 °C high speed.
- If **JET MODE** button is pressed during LH operation, this function is disabled and Power Heating Mode is operated immediately. (only for power heating model)
- In case an error occurred, operation can be interrupted for the protection of the product.
- **COMFORT AIR** and  button cannot be used while the LH function is in operation.

Using the Auto Clean Function

In the Cooling and Dehumidification Mode, moisture is generated inside the indoor unit. This function removes such moisture.

-  is displayed on the display screen.

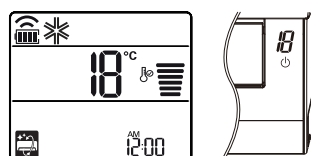

NOTE

- Some functions cannot be used while the Auto Clean function is in operation.
- If you turn off the unit, the fan continues to run for 30 minutes and cleans the inside of the indoor unit.

Using LG SmartThinQ Application

Things to check before using LG SmartThinQ

- For appliances with the  logo
- 1 Check the distance between the appliance and the wireless router (Wi-Fi network).
 - If the distance between the appliance and the wireless router is too far, the signal strength becomes weak. It may take a long time to register or installation may fail.
 - 2 Turn off the **Mobile data** or **Cellular Data** on your smartphone.
 - For iPhones, turn data off by going to **Settings** → **Cellular** → **Cellular Data**.

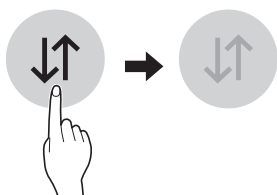

- 3 Connect your smartphone to the wireless router.

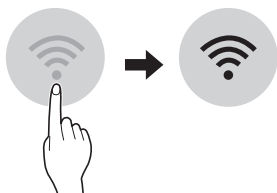

NOTE

- To verify the Wi-Fi connection, check that **Wi-Fi**  icon on the control panel is lit.
- The appliance supports 2.4 GHz Wi-Fi networks only. To check your network frequency, contact your Internet service provider or refer to your wireless router manual.

- LG SmartThinQ is not responsible for any network connection problems or any faults, malfunctions, or errors caused by network connection.
- If the appliance is having trouble connecting to the Wi-Fi network, it may be too far from the router. Purchase a Wi-Fi repeater (range extender) to improve the Wi-Fi signal strength.
- The Wi-Fi connection may not connect or may be interrupted because of the home network environment.
- The network connection may not work properly depending on the Internet service provider.
- The surrounding wireless environment can make the wireless network service run slowly.
- The appliance cannot be registered due to problems with the wireless signal transmission. Unplug the appliance and wait about a minute before trying again.
- If the firewall on your wireless router is enabled, disable the firewall or add an exception to it.
- The wireless network name (SSID) should be a combination of English letters and numbers. (Do not use special characters.)
- Smartphone user interface (UI) may vary depending on the mobile operating system (OS) and the manufacturer.
- If the security protocol of the router is set to **WEP**, you may fail to set up the network. Please change it to other security protocols (**WPA2** is recommended) and register the product again.

Installing LG SmartThinQ

Search for the LG SmartThinQ application from the Google Play Store or Apple App Store on a smart phone. Follow instructions to download and install the application.

NOTE

- If you choose the simple login to access the LG SmartThinQ application, you must go through the appliance registration process each time you change your smartphone or reinstall the application.

Product Registration

- 1 Run the **LG SmartThinQ** application on a smart phone.
- 2 Create an account and sign in.
- 3 Select **Register**.
- 4 Select **Air conditioner**.
- 5 Follow the instruction on the smart phone.

Wi-Fi Function

- For appliances with the  logo
Communicate with the appliance from a smart phone using the convenient smart features.

Using the Application

- 1 Select the appliance in the application and connect it to a Wi-Fi network.
- 2 Select the menu on the upper right side to access settings and features.

Using the Wi-Fi Pairing Function

Once it is connected to the internet through a home Wi-Fi network, you can control the appliance remotely with the application for the smart phone.

- Press and hold the **ENERGY CTRL** and **JET MODE** button simultaneously about 3 seconds.

NOTE

- It is not displayed on the wireless remote control.
- To verify the Wi-Fi connection, check that **Wi-Fi**  icon on the control panel is lit.



Using the Wi-Fi Modem Power Off Function

To reduce power consumption, you can turn off the Wi-Fi modem.

- Press and hold the  and **FAN SPEED** button simultaneously about 3 seconds.

NOTE

- It is not displayed on the wireless remote control.
- After product registration is completed, Wi-Fi modem is turned on when you apply Wi-Fi pairing function in Wi-Fi modem power off state, and it is available as a registered smart phone.

Firmware Update

Keep the appliance performance updated.

Smart Diagnosis™

If you use the Smart Diagnosis function, you will be provided with the useful information such as a correct way of using the appliance based on the pattern of use.

Settings

Allows you to set various options on the appliance and in the application.

NOTE

- If you change your wireless router, your Internet service provider or your password after registering the appliance, please delete it from the LG SmartThinQ **Settings** → **Edit Product** and register again.
- The application is subject to change for appliance improvement purposes without notice to users.
- Functions may vary by model.



Open Source Software Notice Information

To obtain the source code under GPL, LGPL, MPL, and other open source licenses, that is contained in this product, please visit <http://opensource.lge.com>.

In addition to the source code, all referred license terms, warranty disclaimers and copyright notices are available for download.

LG Electronics will also provide open source code to you on CD-ROM for a charge covering the cost of performing such distribution (such as the cost of media, shipping, and handling) upon email request to opensource@lge.com. This offer is valid for three (3) years from the date on which you purchased the product.

Smart Diagnosis™ Using a Smart Phone

- For appliances with the  or  logo

Use this function if you need an accurate diagnosis by an LG Electronics customer information centre when the appliance malfunctions or fails.

Smart Diagnosis™ can not be activated unless the appliance is connected to power. If the appliance is unable to turn on, then troubleshooting must be done without using Smart Diagnosis™.

- 1 Open the **LG SmartThinQ** application on the smart phone.
- 2 Select the air conditioner in dashboard.
- 3 Press **Start Smart Diagnosis** button.
- 4 Follow the instructions on the smart phone.

NOTE

- The Smart Diagnosis™ function depends on the local call quality.
- If the Smart Diagnosis™ data transfer is poor due to poor call quality, you may not receive the best Smart Diagnosis™ service.
- Be sure to keep ambient noise to a minimum or the phone may not correctly receive the buzzer beeps from the indoor unit.

⚠ WARNING

- Before cleaning or performing maintenance, disconnect the power supply and wait until the fan stops.

If the air conditioner will not be used for an extended period of time, dry the air conditioner to maintain it in best condition. Clean the product regularly to maintain optimal performance and to prevent possible breakdown.

- Dry the air conditioner in Fan mode for 3 to 4 hours and disconnect the power. There may be internal damage if moisture is left in its components.
- Before using the air conditioner again, dry the inner components of the air conditioner in Fan mode for 3 to 4 hours. This will help to remove the odor generated from moisture.

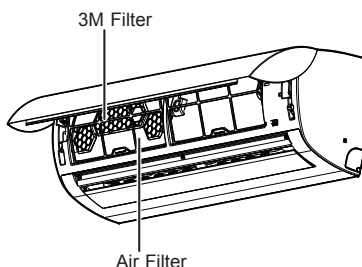

Type	Description	Interval
Air filter	Clean with a vacuum or hand wash.	2 weeks
3M filter	Clean with a vacuum or brush.	Every 6 months
Ionizer	Use dry cotton bud to remove any dust.	Every 6 months
Indoor unit	Clean the Indoor unit surface by using a soft, dry cloth.	Regularly
	Have a professional clean the condensate drain pan.	Once a year
	Have a professional clean the condensate drain pipe.	Every 4 months
	Replace the remote control batteries.	Once a year
Outdoor unit	Have a professional clean the heat exchanger coils and the panel vents. (Consult with technician.)	Once a year
	Have a professional clean the fan.	Once a year
	Have a professional clean the condensate drain pan.	Once a year
	Have a professional verify that all the fan assembly is firmly tightened.	Once a year
	Clean the electric components with air.	Once a year

Clean the Air Filter

Clean the air filters once every 2 weeks, or more, if necessary.

- 1 Turn off the power to the unit.
- 2 Open the front cover.
 - Lift up both sides of the cover slightly.

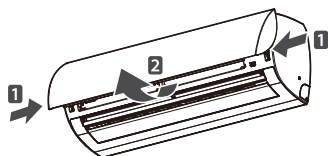

- 3 Hold the knobs of the air filters, pull them down slightly and remove them from the indoor unit.

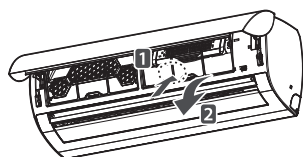

- 4 Clean the filters with a vacuum cleaner or with lukewarm water with neutral detergent.
- 5 Dry the filter in the shade.

NOTE

- The air filter can be broken when it is bent.
- When the air filter is not assembled correctly, dust and other substances can enter into the indoor unit.

Clean the 3M Filter

- 1 Turn off the power to the unit.
- 2 Remove the air filters from the indoor unit.
- 3 Pull out the 3M Filter.

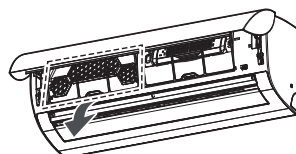

- 4 Use a vacuum cleaner to remove dirt. Do not wash the 3M Filter with water, because the filter can be damaged.

Clean the Ionizer

Turn off the power to the unit.

Use dry cotton bud to remove any dust.

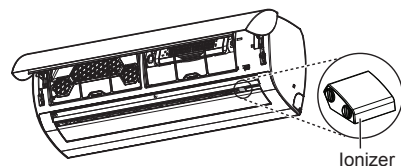

⚠ CAUTION

- Turn off the power and unplug the power cord before you perform any maintenance; otherwise it may cause electric shock.
- Never use water that is higher than 40 °C when you clean the filters. It may cause deformation or discoloration.
- Never use volatile substances when you clean the filters. They may damage the surface of the product.
- Do not wash the 3M filter with water, because the filter can be damaged.

NOTE

- The location and shape of the filters may differ, depending on the model.
- Make sure to clean the heat exchanger coils of the outdoor unit regularly, as dirt collected in the coils may decrease the operational efficiency or increase energy costs.

Self-diagnosis Function

This product has a built-in self-diagnosis function. If an error occurs, the lamp of the indoor unit will blink in 2 second intervals. If this occurs, contact your local dealer or service center.

Before Calling for Service

Please check the following before you contact the service center. If the problem persists, contact your local service center.

Problem	Possible Causes	Corrective Action
The air conditioner does not work normally.	Burning smell and strange sounds are coming from the unit.	<ul style="list-style-type: none"> • Turn off the air conditioner, switch OFF, or disconnect the power supply, and contact the service center.
	Water leaks from the indoor unit even when the humidity level is low.	
	The power cable is damaged or it is generating excessive heat.	
	A switch, a circuit breaker (safety, ground), or a fuse is not operated properly.	
The air conditioner does not work.	The unit generates an error code from its self-diagnosis.	
	The air conditioner is unplugged.	<ul style="list-style-type: none"> • Check whether the power cord is plugged into the outlet or the power isolators are switched on.
	A fuse exploded, or the power supply is blocked.	<ul style="list-style-type: none"> • Replace the fuse or check if the circuit breaker has tripped.
	A power failure has occurred.	<ul style="list-style-type: none"> • Turn off the air conditioner when a power failure occurs. • When the power is restored, wait 3 minutes, and then turn on the air conditioner.
	The voltage is too high or too low.	<ul style="list-style-type: none"> • Check if the circuit breaker has tripped.
	The air conditioner was turned off automatically at a preset time.	<ul style="list-style-type: none"> • Turn the air conditioner on.
The battery setting in the remote controller is incorrect.	<ul style="list-style-type: none"> • Make sure that the batteries are inserted correctly in your remote controller. • If the batteries are placed correctly, but the air conditioner still does not operate, replace the batteries and try again. 	

Problem	Possible Causes	Corrective Action
The air conditioner does not emit cool air.	Air is not circulating properly.	<ul style="list-style-type: none"> • Make sure that there are no curtains, blinds, or pieces of furniture blocking the front of the air conditioner.
	The air filter is dirty.	<ul style="list-style-type: none"> • Clean the air filter once every 2 weeks. • See "Clean the Air Filter" for more information.
	The room temperature is too high.	<ul style="list-style-type: none"> • In summer, cooling the indoor air fully may take some time. In this case, select the Jet Mode to cool the indoor air quickly.
	Cold air is escaping from the room.	<ul style="list-style-type: none"> • Make sure that no cold air is escaping through the ventilation points in the room.
	The desired temperature is higher than the current temperature.	<ul style="list-style-type: none"> • Set the desired temperature to a level lower than the current temperature.
	There is a heating source nearby.	<ul style="list-style-type: none"> • Avoid using heat generators like electric ovens or gas burners while the air conditioner is in operation.
	Fan Mode is selected.	<ul style="list-style-type: none"> • During Fan Mode, air blows from the air conditioner without cooling or heating the indoor air. • Switch the operation mode to cooling operation.
	Outside temperature is too high.	<ul style="list-style-type: none"> • The cooling effect may not be sufficient.
The fan speed cannot be adjusted.	The Jet Mode, or Auto Operation Mode is selected.	<ul style="list-style-type: none"> • In some operation modes, you cannot adjust the fan speed. Select an operation mode in which you can adjust the fan speed.
The temperature cannot be adjusted.	The Fan Mode or Jet Mode is selected.	<ul style="list-style-type: none"> • In some operation modes, you cannot adjust the temperature. Select an operation mode in which you can adjust the temperature.
The air conditioner stops during operation.	The air conditioner is suddenly turned off.	<ul style="list-style-type: none"> • The Timer Function may have timed out, which turns the unit off. Check the timer settings.
	A power failure has occurred during operation.	<ul style="list-style-type: none"> • Wait for the power to come back. If you have the Auto Restart function enabled, your unit will resume its last operation several minutes after power is restored.
The indoor unit is still operating even when the unit has been turned off.	The Auto Clean function is being operated.	<ul style="list-style-type: none"> • Allow the Auto Clean function to continue since it removes any remaining moisture inside the indoor unit. If you do not want this feature, you can turn the unit off.
The air outlet on the indoor unit is discharging mist.	The cooled air from the air conditioner makes mist.	<ul style="list-style-type: none"> • When the room temperature decreases, this phenomenon will disappear.
Water leaks from the outdoor unit.	In the heating operations, condensed water drops from the heat exchanger.	<ul style="list-style-type: none"> • This symptom requires installing a drain hose under the base pan. Contact the installer.

Problem	Possible Causes	Corrective Action
There is noise or vibration.	A clicking sound can be heard when the unit starts or stops due to movement of the reversing valve. Creaking sound: The plastic parts of the indoor unit creak when they shrink or expand due to sudden temperature changes. Flowing or Blowing sound: This is the flow of refrigerant through the air conditioner.	<ul style="list-style-type: none"> • These are normal symptoms. The noise will stop.
The indoor unit gives off an odor.	Odors (such as cigarette smoke) may be absorbed into the indoor unit and discharged with airflow.	<ul style="list-style-type: none"> • If the smell does not disappear, you need to wash the filter. If this does not work, contact the service center to clean your heat exchanger.
The air conditioner does not emit warm air.	When Heating Mode starts, the vane is almost closed, and no air comes out, even though the outdoor unit is operating.	<ul style="list-style-type: none"> • This symptom is normal. Please wait until the unit has generated enough warm air to blow through the indoor unit.
	The outdoor unit is in Defrosting Mode.	<ul style="list-style-type: none"> • In Heating Mode, ice/frost is built up on the coils when the outside temperature falls. This function removes a layer of frost on the coil, and it should finish in approximately 15 minutes.
	Outside temperature is too low.	<ul style="list-style-type: none"> • The heating effect may not be sufficient.
Your home appliance and smartphone is not connected to the Wi-Fi network.	The password for the Wi-Fi that you are trying to connect to is incorrect.	<ul style="list-style-type: none"> • Find the Wi-Fi network connected to your smartphone and remove it, then register your appliance on LG SmartThinQ.
	Mobile data for your smartphone is turned on.	<ul style="list-style-type: none"> • Turn off the Mobile data of your smartphone and register the appliance using the Wi-Fi network.
	The wireless network name (SSID) is set incorrectly.	<ul style="list-style-type: none"> • The wireless network name (SSID) should be a combination of English letters and numbers. (Do not use special characters.)
	The router frequency is not 2.4 GHz.	<ul style="list-style-type: none"> • Only a 2.4 GHz router frequency is supported. Set the wireless router to 2.4 GHz and connect the appliance to the wireless router. To check the router frequency, check with your Internet service provider or the router manufacturer.
	The distance between the appliance and the router is too far.	<ul style="list-style-type: none"> • If the distance between the appliance and the router is too far, the signal may be weak and the connection may not be configured correctly. Move the location of the router so that it is closer to the appliance.

NOTE

- Some functions may not be supported, depending on the model.

Memo

