



## TABLE OF CONTENTS

3	IMPORTANT SAFETY INSTRUCTIONS
8	OVERVIEW
10	PART DESCRIPTION
10	PDRYCB000 (PCB + Case)
10	Accessory
11	Installation
13	INSTALLATION GUIDE
13	Step 1
14	Step 2
15	ADMINISTRATOR GUIDE

## Important Safety Instructions

*READ ALL INSTRUCTIONS BEFORE USING THE APPLIANCE.*

Always comply with the following precautions to avoid dangerous situations and ensure peak performance of your product.

### **⚠ WARNING**

It can result in serious injury or death when the directions are ignored.

### **⚠ CAUTION**

It can result in minor injury or product damage when the directions are ignored.

### **⚠ WARNING**

- Installation or repairs made by unqualified persons can result in hazards to you and others.
- Installation work must be performed in accordance with the National Electric Code by qualified and authorized personnel only.
- The information contained in the manual is intended for use by a qualified service technician familiar with safety procedures and equipped with the proper tools and test instruments.

- Failure to carefully read and follow all instructions in this manual can result in equipment malfunction, property damage, personal injury and/or death.

### **Installation**

- Be sure to request to the service center or installation specialty store when installing products. It will cause fire or electric shock or explosion or injury.
- Request to the service center or installation specialty store when reinstalling the installed product. It will cause fire or electric shock or explosion or injury.
- Do not disassemble, fix, and modify products randomly. It will cause fire or electric shock.
- Be sure to turn off power before installation. It will cause electric shock.
- Installation work must be performed in accordance with the national wiring standards by authorized personnel only.
- Always perform grounding. Otherwise, it may cause electrical shock.
- You need to use a safely insulated power supply which follows IEC61558-2-6 and NEC Class2. If you do not follow, It may cause

fire, electric shock, explosion or injury.

- Securely attach the electrical part cover to Module. If the electric part cover of Module is not attached securely, it could result in a fire or electric shock due to dust, water, etc.
- Make the connections securely so that the outside force of the cable may not be applied to the terminals. Inadequate connection and fastening may generate heat and cause a fire.

### **In-use**

- Do not place flammable stuffs close to the product. It will cause fire.
- Do not allow water to run into the product. It will cause electric shock or breakdown.
- Do not give the shock to the product. It will cause breakdown when giving the shock to the product.
- Request to the service center or installation specialty store when the product becomes wet. It will cause fire or electric shock.
- Do not give the shock using sharp and pointed objects. It will cause breakdown by damaging parts.
- Do not touch the board when the power is connected. It can cause a fire, electric

shock, explosion, injury and problem to the product.

- Unplug the unit if strange sounds, smell, or smoke comes from it. Otherwise, it may cause electrical shock or a fire.
- The appliance must only be supplied at safety extra low voltage corresponding to the marking on the appliance.
- This appliance is not intended to be accessible to the general public.

## **⚠ CAUTION**

### **In-use**

- Do not clean using the powerful detergent like solvent but use soft cloths. It will cause fire or product deformation.
- Do not press the screen using powerful pressure or select two buttons. It will cause product breakdown or malfunction.
- Do not touch or pull the lead wire with wet hands. It will cause product breakdown or electric shock.
- This appliance is not intended for use by persons (including children) with reduced physical, sensory or mental capabilities, or lack of experience and knowledge, unless

they have been given supervision or instruction concerning use of the appliance by a person responsible for their safety. Children should be supervised to ensure that they do not play with the appliance.

- This appliance can be used by children aged from 8 years and above and persons with reduced physical, sensory or mental capabilities or lack of experience and knowledge if they have been given supervision or instruction concerning use of the appliance in a safe way and understand the hazards involved. Children shall not play with the appliance. Cleaning and user maintenance shall not be made by children without supervision.

## Overview

LG Dry Contact is a solution for automatic control of air conditioning system at the owner's behest.

In simple words, it's a switch which can be used to turn the unit On/Off after getting the signal from external sources like key-in lock, door or window switch etc specially used in Hotel rooms.

It's a small PCB that either can be fit inside the control box of Indoor unit or can be outside the unit in a plastic case if there is no sufficient space inside the Indoor unit.

Apart from simple installation, it can also be linked to Central Controller via Indoor unit P1485 pcb. For this, all connecting wires & an additional small pcb for looping is also provided along with Dry Contact.

Dry Contact can be used in two ways.

1. It can be used to actually turn On/Off the system on receiving the signal from the source.  
In this case, user doesn't need to use remote controller anymore to turn On/Off the system.  
However all the further settings like temperature, fan speed, mode etc can be done through remote controller only.
2. Other way is almost similar as above but in this case, after getting the On signal from the external source, user has to turn On the system from remote controller only. Dry contact just activates the system.  
However system can be turned Off directly from the external source. So only On mode is different here.

So in both of above conditions, system can't be operated without signal from external source which prevents unnecessary use of system & facilitates its operation only when its required.

These settings can be selected from the remote controller whose details have been explained in the later part of this manual

So depending upon the requirement, Dry Contact offers a variety of applications to suit the customer's requirement in the best possible way.

\* If the supply cord is damaged, it must be replaced by the manufacturer, its service agent or similarly qualified persons in order to avoid a hazard.

\* Means for disconnection must be incorporated in the fixed wiring in accordance with the wiring rules.

\* Qualified service technician is only possible to access to product.

### Minimum cross-sectional area of conductors

Rated current of appliance A		Nominal cross-sectional area mm <sup>2</sup>
	≤0,2	Tinsel cord <sup>a</sup>
>0,2	and ≤3	0,5 <sup>a</sup>
>3	and ≤6	0,75
>6	and ≤10	1,0 (0,75) <sup>b</sup>
>10	and ≤16	1,5 (1,0) <sup>b</sup>
>16	and ≤25	2,5
>25	and ≤32	4
>32	and ≤40	6
>40	and ≤63	10

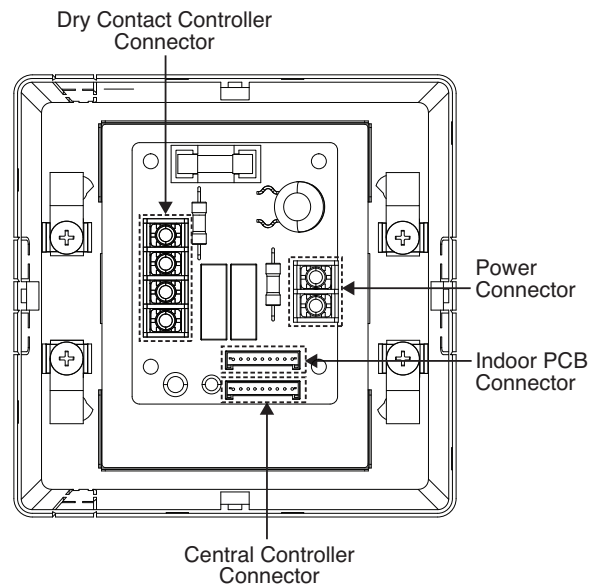

## Part Description

### PDRYCB000 (PCB + Case)

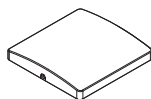

Front Case

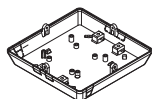

Rear Case

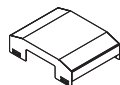

Metal Case (Front)

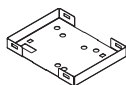

Metal Case (Rear)



Rubber

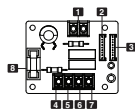

PCBA



Side



Isolation Sheet

- 1 CN\_POWER : Connector
- 2 CN\_CC : Indoor PCB Connector
- 3 CN1 : Central Controller Connector
- 4 CN\_DRY(L) : DRY CONTROLLER Connector
- 5 CN\_DRY(SIG) : DRY CONTROLLER Connector

- 6 CN\_DRY(ERROR CHECK) : ERROR Check Display Connector
- 7 CN\_DRY(OPER STATE) : Operation Display Connector
- 8 FUSE : 250 V / 3.15 A

### Accessory

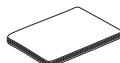
Cable 1EA  
(for connecting with indoor unit)Screw  
(For installation, 4EA)User/Installation  
Manual

#### \*Note

- These cable using for connection between Dry contact and Indoor unit.
- So before using these things Please check the connector type first and use cables on proper indoor unit.

## Installation

- 1) Loosen and remove two screws that secures the product.

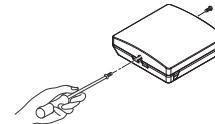

- 2) Remove the front metal case by pressing the marked points.

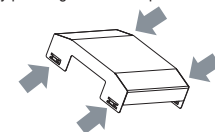

- 3) Position the rear case to the direction (left or right) towards to the connector

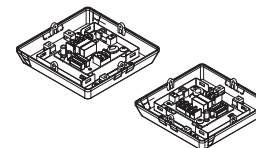

- 4) Remove 4 screws, for strapping wires.

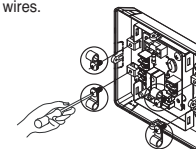

- 5) Secure the rear case on the installation place using the supplied fixing screws.

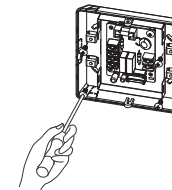

- 6) Remove knock out shapes on the rear case (2-sided) according to the connector's size and direction.

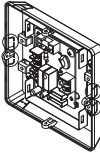

- 7) Connect the connection wires properly according to the connection. When connecting CN-POWER and CN\_DRY(L) to the power cable in the terminal block, make sure to put them inside the square hole of the Clamp as shown in the picture.

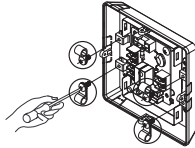

- 8) Set the switch according to the setting method. (Refer to the instruction)  
 9) Combine top part of the metal case with the back side of the metal case.  
 10) Hang the front of the case to the rear case hook and tighten the fixing screws on the bottom part.

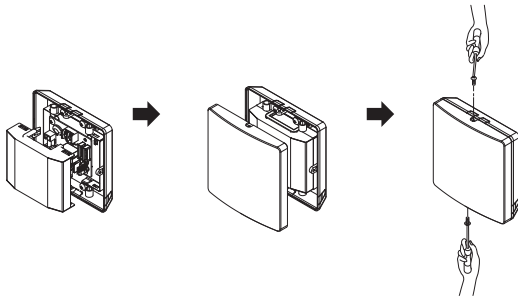

**\*Note**

1. Install the product on flat surface and install anchoring screws at more than 2 places. Otherwise the central controller may not be anchored properly.
2. Do not tighten anchoring screws too tightly. It may cause deformation of the case.
3. Do not deform the case at random. It may cause malfunction of the central controller.

## Installation Guide

### Step 1

- Connect CN-CC with Indoor PCB by the cable(provided)  
 - Connection of Dry contact only

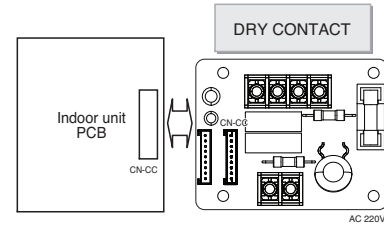

- Connection of Dry contact & LG Central Controller in case of single constant models.

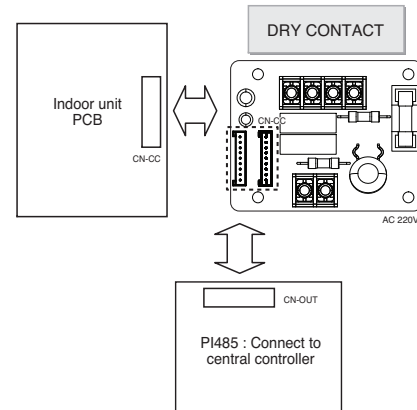

**\* Single Only**

- When you install single product this PCB have to add.

# Administrator Guide

## Step 2

Connect CN\_DRY with Control Unit .  
(Fix SUB PCB into the proper location.)

- To apply power source through PCB

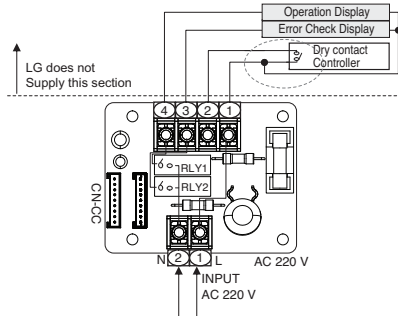

- To apply power source directly to external source

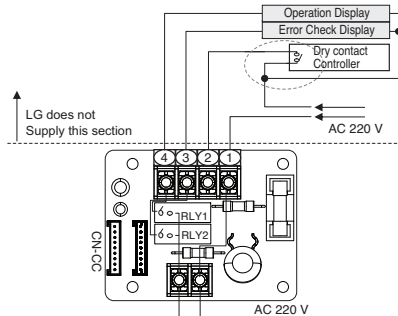

## \* Function

It gives selection whether to turn ON the unit directly or not from the external source. The selection can be made by pressing SET/CLEAR button of the wireless remote controller 3 times within 3 minutes of resetting the unit with facing it towards the unit. (This function availability depends on indoor unit mode)



1. To turn ON the unit directly from the external source
2. Not to turn ON the unit directly from the external source. Only to activate the system.

### \*Note

This function(Dry contact mode setting) doesn't work in some wired remote controller. For more information, please refer to manual of wired remote controller.

If the power gives out, the Air conditioner may be run to before state after power returns because Air conditioner's function of interruption of electric power compensation.



## Disposal of your old appliance(as per e-waste Rules)



1. When this crossed out wheeled bin symbol is depicted on the product and its operator's manual, it means the product is covered by the e-waste Management and Handling Rules, 2011 and are meant to be recycled, dismantled, refurbished or disposed off.

### 2. Dos

- The product is required to be handed over only to the authorized recycle for disposal.
- Keep the product in isolated area, after it becomes non-functional/un-repairable so as to prevent its accidental breakage.

### Don't

- The product should not be opened by the user himself/herself, but only by authorized service personnel.
- The product is not meant for re-sale to any unauthorized agencies/scraper dealer/kabariwalah.
- The product is not meant for mixing into household waste stream.
- Do not keep any replaced spare part(s) from the product in exposed area.

3. Any disposal through unauthorized agencies/person will attract action under Environment (Protection) Act 1986 .

4. This product is complied with the requirement of Hazardous Substances as specified under Rule 13 (1) & (2) of the E-Waste (Management & Handling) Rules, 2011.

5. To locate a nearest collection centre or call for pick-up (limited area only) for disposal of this appliance, please contact Toll Free No. **1800-180-9999** for details. All collection centre and pick up facilities are done by third parties with **LG Electronics India Pvt. Ltd.** Merely as a facilitator. For more detailed information, please visit : <http://www.lge.com/in>.

※ The above information applies only to India.

## अपने पुराने नपिटान के उपकरण ( ई-अपशष्टि नयिम के अनुसार )



1. जब इस काटे गए पहिये वाले बनि का चनिह कसिी उपकरण और इसके ओपरेटर की पुसतकिा के साथ संलग्न होता है तो इसका मतलब है कि इसे "ई-अपशष्टि" (परबंधन और हथालन ) नयिम २०११ के अंतर्गत सममलिति कयिा गया है , और इसे नवीनीकरणकरन ,वघितन और नपिटान के लिए बनाया गया है ।

### 2. करें

क . उपकरण को सरिफ अधकित पुनः नवीनीकरणकर्ता को ही नपितारन करने हेतु हस्तान्तरति करें ।

ख. जब उपकरण कार्यरत न हो इसे अलग क्शेत्तर में रखें ताकि उपकरण से होने वाली दुर्घटनाओं से बचा जा सके ।  
न करें

क. इस उपकरण को स्वयं/खुद नहीं खोलना चाहिए ! उपकरण को केवल अधकित अधकिारी के द्वारा ही खोला जाना चाहिए ।

ख. इस उपकरण को पुनः बकिरी के लिए कसिी भी कबाडीवाला / भंगार-वाला / अनाधकित संस्था को न दें ।

ग. इस उपकरण को कसिी घरेलू अपशष्टि सामान के साथ मलिकर न रखें ।

घ. उपकरण के बदले हुए या आंतरकि पुरजो को खुले क्शेत्तर में न रखें ।

3. यदि कसिी अनाधकित वभिग या व्यक्ती के द्वारा नपिटारन कयिा जाता है तो यह पर्यावरण (सुरक्षा) धारा १९८६ के अंतर्गत आता है ।

4. यह उत्पाद खतरनाक पदार्थों के लिए बनाये गए नयिमांक १३ (१) और (२), ई -वेस्ट (परबन्धन और रखरखाव) नयिम २०११ के कानून का पालन करता है.

5. उपरोक्त पदार्थों के नपिटारन के लिए नजदीकी नपिटारन संस्थान (संकीरण क्शेत्तर )में कॉल करें। अधकि जानकारी के लिए हमारे टोल फ्री नंबर **1800-180-9999** पर कॉल करें. सभी संग्रहण केंद्र व पकि-अप की सुवधिएं कसिी थर्ड-पार्टी जो "LG Electronics India Pvt. Ltd." को अपनी सेवाएं प्रदान कर रही हैं, से करवाएं ।

ज्यादा जानकारी के लिए देखें वेब:साईट - <http://www.lge.com/in>

※ ऊपर दी गई जानकारी केवल भारत पर लागू होती है।