

OWNER'S MANUAL

AIR-TO-WATER HEAT PUMP

Please read this manual carefully before operating your set and retain it for future reference.

THERMA V™

Original instruction

[Representative] LG Electronics Inc. EU Representative : LG Electronics European Shared Service Center B.V. Krijgsman 1, 1186 DM Amstelveen, The Netherlands

[Manufacturer] LG Electronics Inc. Changwon 2nd factory 84, Wanam-ro, Seongsan-gu, Changwon-si, Gyeongsangnam-do, KOREA



MFL68680905
Rev.07_072920

www.lg.com
Copyright © 2017 - 2020 LG Electronics Inc. All Rights Reserved.

PORTUGUÊS

ENGLISH

MAGYAR

ITALIANO

БЪЛГАРСКИ

ESPAÑOL

SRPSKI

FRANÇAIS

HRVATSKI

DEUTSCH

SLOVENŠČINA

EMHNIKA

УКРАЇНЬСЬКА

ČEŠTINA

DANSK

NEDERLANDS

POLSKI

LIMBA ROMÂNĂ

INTRODUCTION

What is AWHP(Air to Water Heat Pump)?

- Air to Water Heat Pump system can be used as various heating solution from floor heating to hot water supply with multiple heat sources. It is 4 times more energy efficient than conventional system.
- High efficiency with conventional boiler functions.

Why is AWHP(Air to Water Heat Pump)?

- Various regulations are implemented in Europe to reduce energy use of building heating.
- Also, AWHP-related subsidy programs are implemented by country.

Read this manual

Inside you will find many helpful hints on how to use and maintain your AWHP properly. Just a little preventive care on your part can save you a great deal of time and money over the life of your product.

You'll find many answers to common problems in the chart of troubleshooting tips. If you review our chart of Troubleshooting Tips first, you may not need to call for service at all.

For your records

Staple your receipt to this page in case you need it to prove the date of purchase or for warranty purposes. Write the model number and the serial number here:

Model number : _____

Serial number : _____

You can find them on a label on the side of each unit.

Dealer's name : _____

Date of purchase : _____

TABLE OF CONTENTS

2 INTRODUCTION

5 SAFETY INSTRUCTIONS

11 PRODUCT INTRODUCTION

- 11 Typical installation scene (For Split)
- 12 Typical installation scene (For Hydrosplit)
- 13 Remote controller

14 DESCRIPTION OF THE OPERATION

- 14 Main screen
- 14 Menu screen
- 15 Setting screen
- 15 Popup screen
- 16 Monitoring(For Split)
- 16 Returning to the screen
- 17 Monitoring(For Hydrosplit)

18 OPERATION SETTING

- 18 On / Off
- 18 Operation mode
- 19 Cooling operation
- 20 Heating operation
- 21 AI / Auto operation

22 TEMPERATURE SETTING

- 22 Controlling desired temperature
- 23 Select Temperature Sensor
- 24 DHW heating operation
- 24 Quick DHW tank heating
- 25 View temperature

27 LOCK SETTING

- 27 How to enter Lock setting
- 27 Lock setting – all, on/off, mode, DHW lock

28 TIMER SETTING

- 28 Timer entrance and setting method
- 29 Simple Timer
- 30 Turn-On Reservation
- 31 Turn-Off Reservation

32 SCHEDULE SETTING

- 32 How to enter schedule
- 33 Daily schedule
- 34 Schedules & Edit
- 35 Schedules & Edit – Add schedule

4 TABLE OF CONTENTS

36 Exception Day

37 METER INTERFACE SETTING

37 Connection path of meter interface

38 Information of meter interface

39 FUNCTION SETTING

39 How to enter function setting

40 Function setting

41 Low Noise Mode Time

42 Wi-Fi Pairing

43 Water Temperature Setting

44 3rd Party Boiler

45 USER SETTING

45 How to enter user setting

45 User Setting

46 Language

47 Temperature Unit

48 Screen Saver Timer

48 LCD Brightness In Idle

49 Date

50 Time

51 Summer Time

52 Password

53 Schedule Initialization

54 Theme

54 System Reboot

55 OVERVIEW OWNER'S SETTINGS

55 Menu structure

57 USING THERMOSTAT

57 How to use thermostat

58 EMERGENCY OPERATION





60 MAINTENANCE AND SERVICE

60 Maintenance activities

60 When the unit is not going...

60 Call the service immediately in the following situations

SAFETY INSTRUCTIONS

	Read the precautions in this manual carefully before operating the unit.		This appliance is filled with flammable refrigerant (R32)
	This symbol indicates that the Operation Manual should be read carefully.		This symbol indicates that a service personnel should be handling this equipment with reference to the Installation Manual.

The following safety guidelines are intended to prevent unforeseen risks or damage from unsafe or incorrect operation of the appliance.

The guidelines are separated into 'WARNING' and 'CAUTION' as described below.

 This symbol is displayed to indicate matters and operations that can cause risk.
Read the part with this symbol carefully and follow the instructions in order to avoid risk.

WARNING

This indicates that the failure to follow the instructions can cause serious injury or death.

CAUTION

This indicates that the failure to follow the instructions can cause the minor injury or damage to the product.

WARNING

- Always ground the product.
 - There is a risk of electric shock.
- Do not use a defective or underrated circuit breaker. Use the correctly rated breaker and fuse.
 - There is risk of fire or electric shock.
- Do not use a multi outlet. Always use this appliance on a dedicated circuit and breaker.
 - There is risk of fire or electric shock.

- For electrical work, contact the dealer, seller, a qualified electrician, or an Authorized Service Center. Do not disassemble or repair the product by yourself.
 - There is risk of fire or electric shock.
- Always ground the product as per the wiring diagram. Do not connect the ground wire to gas or water pipes lightning rod or telephone ground wire.
 - There is risk of fire or electric shock.
- Install the panel and the cover of control box securely.
 - There is risk of fire or electric shock due to dust, water etc.
- Use the correctly rated breaker or fuse.
 - There is risk of fire or electric shock.
- Do not modify or extend the power cable. If the power cable or cord has scratches or skin peeled off or deteriorated then it must be replaced.
 - There is risk of fire or electric shock.
- For installation, removal or reinstall , always contact the dealer or an Authorized Service Center.
 - There is risk of fire, electric shock, explosion, or injury.
- Do not install the product on a defective installation stand. Be sure that the installation area does not deteriorate with age.
 - It may cause product to fall.
- Never install the unit on a moving base or a place from where it can fall down.
 - The falling unit can cause damage or injury or even death of a person.
- When the product is soaked (flooded or submerged) in water, contact an Authorized Service Center for repair before using it again.
 - There is risk of fire or electric shock.
- Be sure to check the refrigerant to be used. Please read the label on the product.
 - Incorrect refrigerant can prevent the normal operation of the unit.
- Don't use a power cord, a plug or a loose socket which is damaged.
 - Otherwise it may cause a fire or electrical shock.
- Do not touch , operate, or repair the product with wet hands.
 - There is risk of electric shock or fire.
- Do not place a heater or other heating appliances near the power cable.
 - There is risk of fire and electric shock.
- Do not allow water to run into electric parts. Install the unit away from water sources.
 - There is risk of fire, failure of the product, or electric shock.
- Do not store or use or even allow flammable gas or combustibles near the product.
 - There is risk of fire.

- Wiring connections must be secured tightly and the cable should be routed properly so that there is no force pulling the cable from the connection terminals.
 - Improper or loose connections can cause heat generation or fire.
- Safely dispose off the packing materials. Like screws, nails, batteries, broken things etc after installation or service and then tear away and throw away the plastic packaging bags.
 - Children may play with them and cause injury.
- Make sure to check that the power device is not dirty, loose or broken and then turn on the power.
 - Dirty, loose or broken power device can cause electric shock or fire.
- In unit the step-up capacitor supplies high voltage electricity to the electrical components. Be sure to discharge the capacitor completely before conducting the repair work.
 - An charged capacitor can cause electrical shock.
- When installing the unit, use the installation kit provided with the product.
 - Otherwise the unit may fall and cause severe injury.
- Be sure to use only those parts which are listed in the service parts list. Never attempt to modify the equipment.
 - The use of inappropriate parts can cause an electrical shock, excessive heat generation or fire.
- Do not use the product in a tightly closed space for a long time. Perform ventilation regularly.
 - Oxygen deficiency could occur and hence harm your health.
- Do not open the front cover or grille of the product during operation. (Do not touch the electrostatic filter, if the unit is so equipped.)
 - There is risk of physical injury, electric shock, or product failure.
- If strange sounds, smell or smoke comes from product, immediately turn the breaker off or disconnect the power supply cable.
 - There is risk of electric shock or fire.
- Ventilate the product room from time to time when operating it together with a stove, or heating element etc.
 - Oxygen deficiency can occur and hence harm your health.
- Turn the main power off when cleaning or repairing the product.
 - There is risk of electric shock.
- Take care to ensure that nobody especially kids could step on or fall onto the unit.
 - This could result in personal injury and product damage.
- Take care to ensure that power cable could not be pulled out or damaged during operation.
 - There is risk of fire or electric shock.

- Do not touch any electric part with wet hands. you should be cut power before touching electric part.
 - There is risk of electric shock or fire.
- Do not touch refrigerant pipe and water pipe or any internal parts while the unit is operating or immediately after operation.
 - There is risk of burns or frostbite, personal injury.
- If you touch the pipe or internal parts, you should be wear protection or wait time to return to normal temperature.
 - Otherwise , it may cause burns or frostbite, personal injury.
- Do not touch leaked refrigerant directly.
 - There is risk of frostbite.
- Make sure to install mixing valve (field supply). The mixing valve is setting the water temperature. The hot water temperature maximum values shall be selected according to the applicable legislation.
- Do not heated to a temperature of more than provided by the product.
 - Otherwise, it may cause fire or damage of product.
- This appliance is intended to be used by expert or trained users in shops, in light industry and on farms, or for commercial use by lay persons.
- Do not step on the unit and do not put anything on it.
It may cause an injury through dropping of the unit or falling down.
- Use a vacuum pump or Inert (nitrogen) gas when doing leakage test or air purge. Do not compress air or Oxygen and Do not use Flammable gases. Otherwise, it may cause fire or explosion.
 - There is the risk of death, injury, fire or explosion.
- The appliance shall be stored in a well-ventilated area where the room size corresponds to the room area as specified for operation.
- The appliance shall be stored in a room without continuously operating open flames (for example an operating gas appliance) and ignition sources (for example an operating electric heater).
- The appliance shall be stored so as to prevent mechanical damage from occurring.(for R32)
- Any person who is involved with working on or breaking into a refrigerant circuit should hold a current valid certificate from an industry-accredited assessment authority, which authorises their competence to handle refrigerants safely in accordance with an industry recognised assessment specification.(for R32)
- Keep any required ventilation openings clear of obstruction.(for R32)
- Servicing shall only be performed as recommended by the equipment manufacturer. Maintenance and repair requiring the assistance of other skilled personnel shall be carried out under the supervision of the person competent in the use of flammable refrigerants. (for R32)

- The appliance shall be stored in a well-ventilated area where the room size corresponds to the room area as specified for operation. (for R32)
- The appliance shall be stored in a room without continuously operating open flames (for example an operating gas appliance) and ignition sources (for example an operating electric heater). (for R32)

CAUTION

- Two or more people must lift and transport the product.
 - Avoid personal injury.
- Do not install the product where it will be exposed to sea wind (salt spray) directly.
 - It may cause corrosion on the product.
- Keep level even when installing the product.
 - To avoid vibration or noise.
- Do not install the product where the noise or hot air from the unit could damage or disturb the neighborhoods.
 - It may cause a problem for your neighbors and hence dispute.
- Always check for gas (refrigerant) leakage after installation or repair of product.
 - Low refrigerant levels may cause failure of product.
- Do not use the product for special purposes, such as preserving foods, works of art, etc. It is a consumer AWHP, not a precision refrigeration system.
 - There is risk of damage or loss of property.
- Do not block the inlet or outlet of air flow.
 - It may cause product failure.
- Use a soft cloth to clean. Do not use harsh detergents, solvents or splashing water etc.
 - There is risk of fire, electric shock, or damage to the plastic parts of the product.
- Do not step on or put anything on the product.
 - There is risk of personal injury and failure of product.
- Do not insert hands or other objects through the air inlet or outlet while the product is operating.
 - There are sharp and moving parts that could cause personal injury.
- Be cautious when unpacking and installing the product.
 - Sharp edges could cause injury.
- If the refrigerant gas leaks during the repair, do not touch the leaking refrigerant gas.
 - The refrigerant gas can cause frostbite (cold burn).

- Do not tilt the unit when removing or uninstalling it.
 - The condensed water inside can spill.
- Do not mix air or gas other than the specified refrigerant used in the system.
 - If air enters the refrigerant system, an excessively high pressure results, causing equipment damage or injury.
- If the refrigerant gas leaks during the installation, ventilate the area immediately.
 - Otherwise it can be harmful for your health.
- Dismantling the unit, treatment of the refrigerant oil and eventual parts should be done in accordance with local and national standards.
- Do not expose your skin or kids or plants to the cool or hot air draft.
 - This could harm to your health.
- Use a firm stool or ladder when cleaning, maintaining or repairing the product at an height.
 - Be careful and avoid personal injury.
- The hot water may not be available immediately, during disinfection operation or depending on the amount of hot water.
- During floor heating operation it is important to limit the minimum/maximum water temperature.
- If anyone other than a licensed Professional installs, repairs, or alters LG Electronics Air Conditioning Products, the warranty is voided.
 - All costs associated with repair are then the full responsibility of the owner.
- Do not install the unit in potentially explosive atmospheres.

This appliance is not intended for use by persons (including children) with reduced physical, sensory or mental capabilities or lack of experience and knowledge, unless they have been given supervision or instruction concerning use of the appliance by a person responsible for their safety. Children should be supervised to ensure that they do not play with the appliance.

This appliance can be used by children aged from 8 years and above and persons with reduced physical, sensory or mental capabilities or lack of experience and knowledge if they have been given supervision or instruction concerning use of the appliance in a safe way and understand the hazards involved. Children shall not play with the appliance. Cleaning and user maintenance shall not be made by children without supervision.

PRODUCT INTRODUCTION

Typical installation scene (For Split)

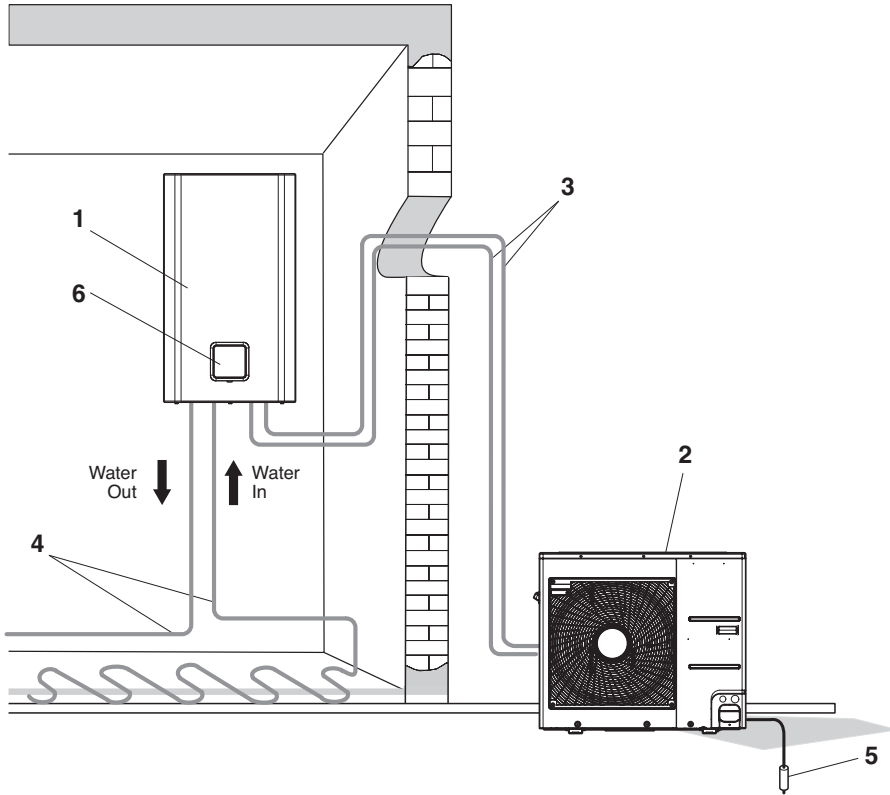

1. Indoor unit
2. Outdoor unit
3. Refrigerant pipe and connecting cable
4. Water pipe
5. Ground wire to ground outdoor unit to prevent electrical shocks.
6. Remote controller

*The shape of products can be changed according to the model capacity and type.

Typical installation scene (For Hydrosplit)

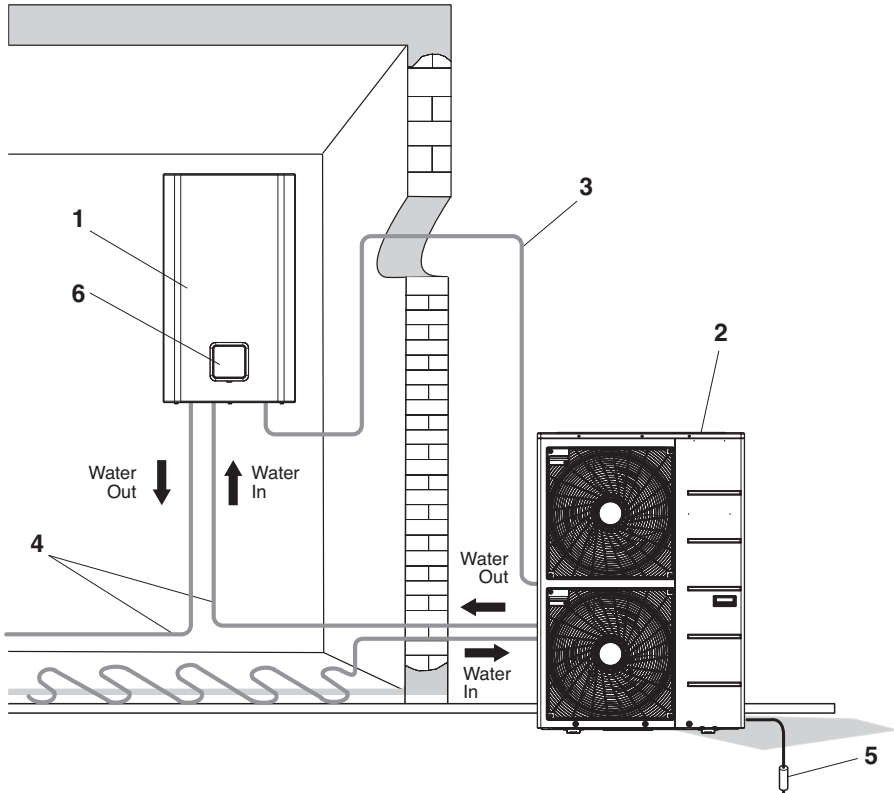

1. Indoor unit
2. Outdoor unit
3. Connecting cable
4. Water pipe
5. Ground wire to ground outdoor unit to prevent electrical shocks.

*The shape of products can be changed according to the model capacity and type.

Remote controller

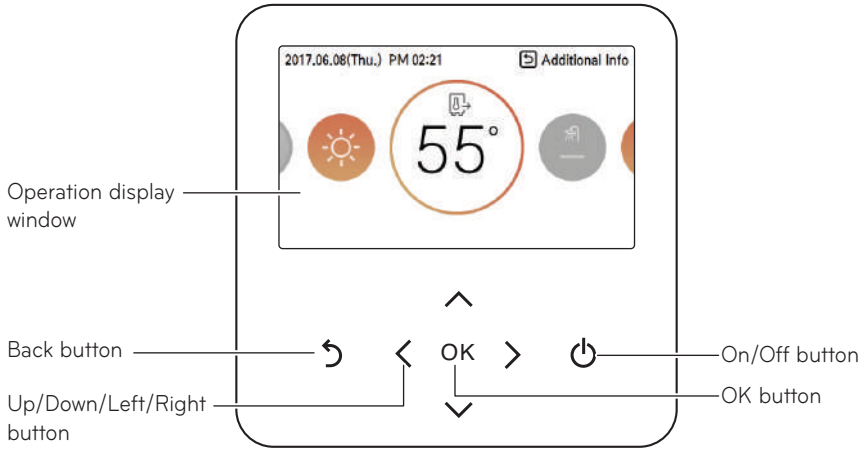

Operation display window	Operation and Settings status display
Back button	When you move to the previous stage from the menu's setting stage
Up/down/left/right button	When you change the menu's setting value
OK button	When you save the menu's setting value
On/Off button	When you turn ON/OFF the AWHP

NOTE

- The remote controller is located on the indoor unit from factory. It can be repositioned at living space using cover plate accessory kit.
- Some functions may not be operated and displayed depending on the product type.
- The actual product can be different from above contents depending upon model type.
- When using simultaneous operation system, whenever press remote controller button, system will approximately operate after 1~2 minutes.

DESCRIPTION OF THE OPERATION

Main screen

In the main screen, press [\leftarrow , \rightarrow (left/right)] button to select the category to set, and you can control by pressing [\wedge , \vee (up/down)] button.

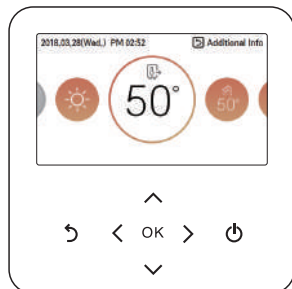

Menu screen

In the main screen, press [\leftarrow , \rightarrow (left/right)] button to select the menu and press [OK] button to move to menu screen.

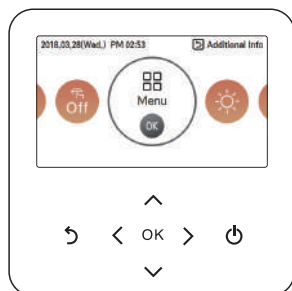

In the menu screen, press [\leftarrow , \rightarrow (left/right)] button to select the category to set, and press [OK] button to move to the detail screen.

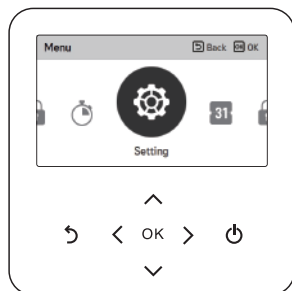

Setting screen

Select the category to set using [\wedge , \vee (up/down)] button.



In each detail screen of the menu, as in the box in the left figure, when "<,>" icons are displayed at the same time, you can immediately apply the setting value by pressing [<, >(left/right)] button.

※ For the values that can be set in each category, refer to the detail manual for each function.

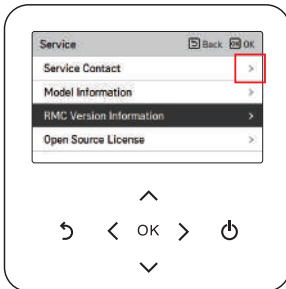

In each detail screen of the menu, as in the box in the left figure, if only ">" icon is displayed, you can move to the detail setting screen by pressing [>(right) or OK] button.

※ For the values that can be set in each category, refer to the detail manual for each function.

Popup screen

The toast message is the message displayed at the bottom of the screen when an operation is turned On/Off or if a function is set / canceled.

The popup message is mainly displayed when an error occurred in the product.

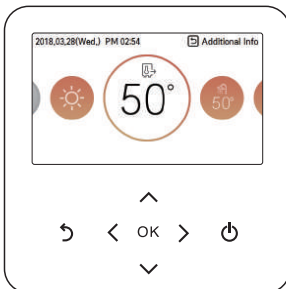

< Toast message >



< Popup message >

Monitoring(For Split)

In the main screen, you can enter the monitoring screen by pressing [Back] button
 In the monitoring screen, you can check the following information,

- The room temperature
- The water inlet / outlet temperature
- The water pump operation

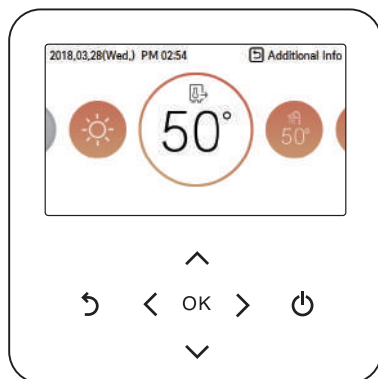

Returning to the screen

In the main screen, after moving to the category by pressing [<, >(left/right)] button, if there is no remote controller operation, after 10 seconds, it returns to the main screen basic position. (basic position: indoor temperature display part)

In the screens except the main screen, if there is no remote controller operation for 1 minute, it moves to the main screen.

Monitoring (For Hydrosplit)

In the main screen, you can enter the monitoring screen by pressing [Back] button
In the monitoring screen, you can check the following information,

- The room temperature
- The water inlet / outlet temperature
- The water pump operation
- The water flow rate
- The water pressure

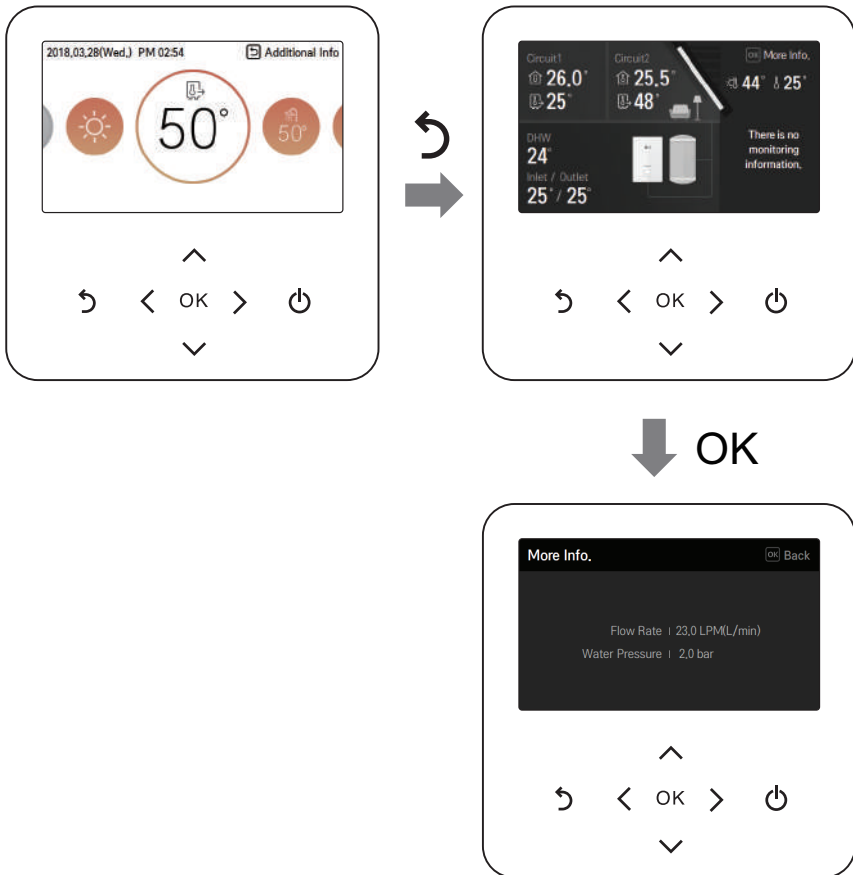

Returning to the screen

In the main screen, after moving to the category by pressing [<, >(left/right)] button, if there is no remote controller operation, after 10 seconds, it returns to the main screen basic position. (basic position: indoor temperature display part)

In the screens except the main screen, if there is no remote controller operation for 1 minute, it moves to the main screen.

OPERATION SETTING

On / Off

THERMA V. will be turned on or off.

Press the remote controller's  (On/Off) button.

- If the product is in operation, On/Off button will be illuminated.

If the product is in off, On/Off button backlight will be off.

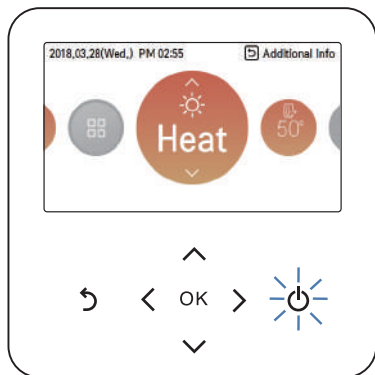

Operation mode

You can easily control the desired operation mode.

In the main screen, press [\leftarrow , \rightarrow] (left/right) button to select the operation mode or home leave or hold category, and press [\wedge , \vee] (up/down) button to set the operation mode.

※ Some products may not support some operation modes.

Mode	Description
Cool	Cool the room to the desired temperature. Activated when No. 4 ON of indoor unit PCB DIP SW 2. (Refer to installer setting.)
Heat	Heats the room to the desired room temperature.
AI / Auto	The product automatically provides the appropriate fan speed based on the temperature of the room.

Cooling operation

Cooling operation's minimum setting temperature is 5 °C.

- The desired temperature can be controlled in the units of 1 °C.
- Set the desired temperature lower than the water temperature.
- water temperature is displayed on the default screen of the remote controller.
- If the setpoint is set higher than the water temperature, then the unit will remain in the cool mode but will not begin to cool the water temperature exceeds the setpoint.
- If your unit is operating in cooling mode and you press the [On/Off] button the cooling operation will shut off.

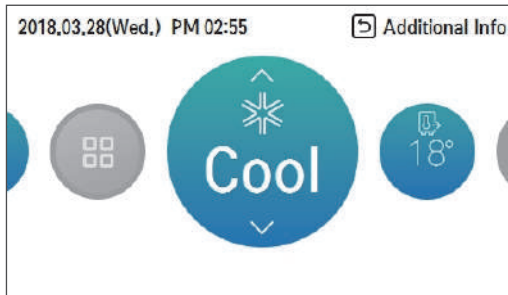

NOTE

Activated when No. 4 ON of indoor unit PCB DIP SW 2 (Refer to installer setting)

What is 3 minutes delay function?

After the cooling stops, when the product is started right away, the reason that the cold water does not come out is that it is the function to protect the compressor.

The compressor starts after 3 minutes and the cold water comes out.

NOTE

The compressor starts after 3 minutes and the cold water comes out.

In the cooling operation, you can select the desired temperature in the range of 5 °C~27 °C.

The favorable temperature difference between the water inlet temperature and outlet temperature is 5 °C.

Heating operation

The heating operation's minimum setting temperature is 15 °C.

- The desired temperature can be controlled in the units of 1 °C.
- Set the desired temperature higher than the water temperature.
- Water temperature is displayed on the default screen of the remote controller.
- When the desired temperature is set lower than the water temperature, warm water doesn't come out.
- If your unit is operating in heating mode and you press the [On/Off] button the heating operation will shut off.

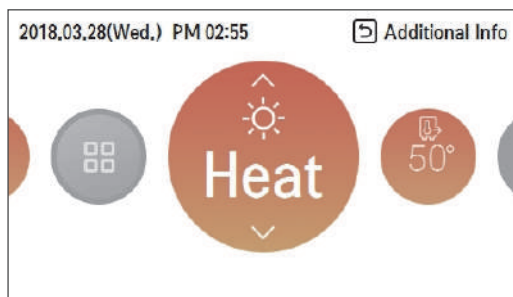

NOTE

In the heating operation, you can select the desired temperature in the range of 15 °C~65 °C.

NOTE

- When the E/heater is not used, the minimum temperature of the water temperature can be set from 34 °C to 20 °C.

AI / Auto operation

In order to save energy and to give highest comfort, setting temperature will follow outside temperature. If outdoor temperature decreases, heating capacity for the house will increase automatically in order to keep same room temperature. All parameters will be set by installer during start-up procedure and will be adapted to the site characteristic.

1. Select AI / Auto mode.

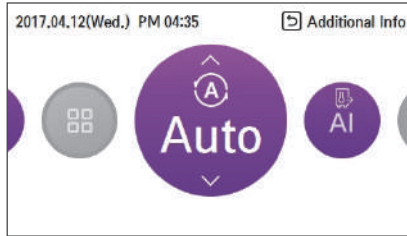

2. Select the desired temperature category

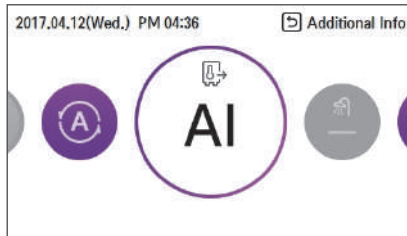

3. Adjust the desired temperature level by press [∧, ∨ (up/down)] button.

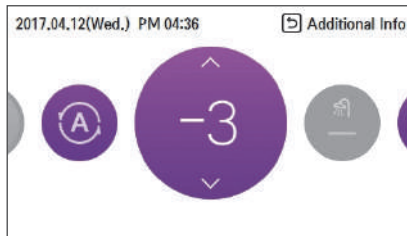

NOTE

Decreasing temperature profile by 3 °C (based on room air temperature)

<Temperature adjust step (unit : °C)>

-5, -4, -3, -2, -1, 0, 1, 2, 3, 4, 5

← Cold

Hot →

TEMPERATURE SETTING

Controlling desired temperature

You can easily control to the desired temperature.

- In the main screen, press [$<$, $>$ (left/right)] button to select the desired temperature category, and press [\wedge , \vee (up/down)] button to set the desired temperature.
 - In the cooling, heating, and AI/auto mode, the desired temperature control is possible.

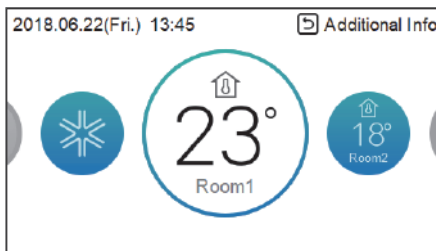
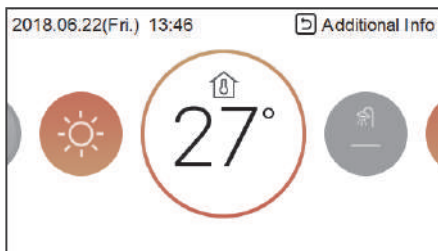

Mode	Description
Room temperature	Room temperature setting is available when remote room air sensor (sold separately) is installed
Room1 & Room2 temperature	Temperature of Room 1 and Room 2 can be set respectively, when 2nd circuit option is activated in installer mode.
Leaving water temperature	If the desired temperature is lower than the water temperature, the heating is not performed. Set the desired temperature higher than the water temperature.
DHW tank temperature	DHW tank temperature setting is available when DHW tank is installed.
Water inlet temperature	This operation is changed to the temperature sensor only, the inlet temperature sensor, and temperature control logic is the same as the leaving water temperature operation.
Room temperature + Leaving water temperature	Room temperature setting is available when remote room air sensor (sold separately) is installed. If the desired temperature is lower than the water temperature, the heating is not performed. Set the desired temperature higher than the water temperature.

NOTE

The function can be activated according to the installer setting.

Select Temperature Sensor

There are 3 sensor options, air only, leaving water only, and air+water in installer mode.

Sensor Locations are not available on all models.

(For R410A Split)
(For R32 Split)



(For Hydrosplit)

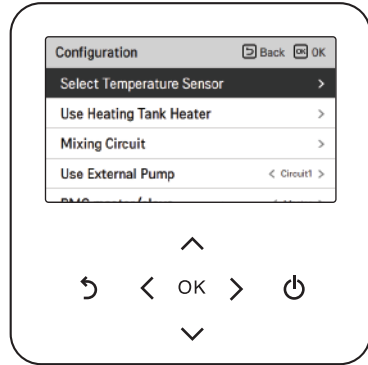

(For R410A Split)

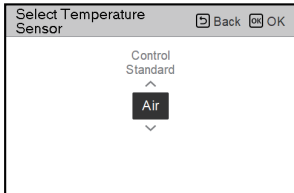

(For R32 Split)
(For Hydrosplit)

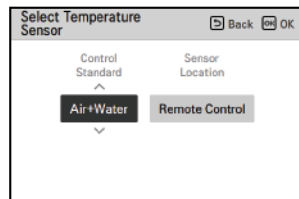
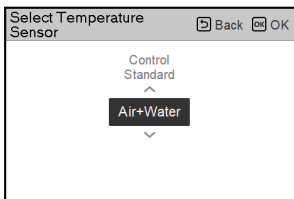
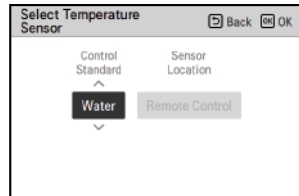
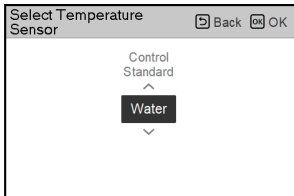
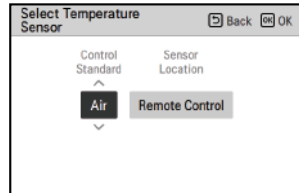

DHW heating operation

Function to set whether or not to use a installed DHW tank

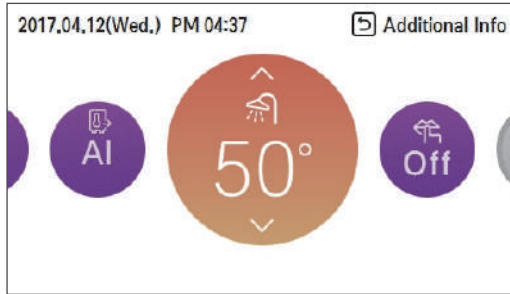

NOTE

- This function is not used when the DHW tank is not installed.
- If you want to know more information, refer function on installation information section.

Quick DHW tank heating

If there is urgent DHW heating demand, Quick DHW Tank Heating mode can be used to reduce the time to reach target DHW tank temperature by forcibly turning on DHW tank heater.

After reaching target DHW tank temperature or by user's input to stop, Quick DHW Tank Heating mode will be finished.

1. Press down [Back] button for a second focused on DHW Heating Operation.

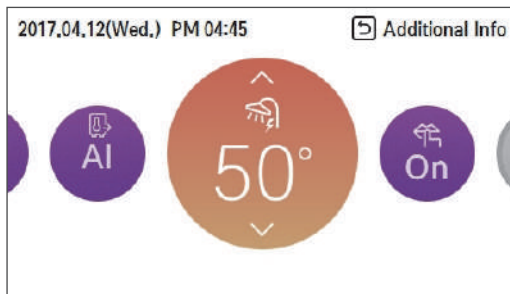

View temperature

General mode

You can check the current temperature.

- In the main screen, you can enter the monitoring screen by pressing [Back] button.

(For R410A Split)

(For R32 Split)

(For Hydrosplit)

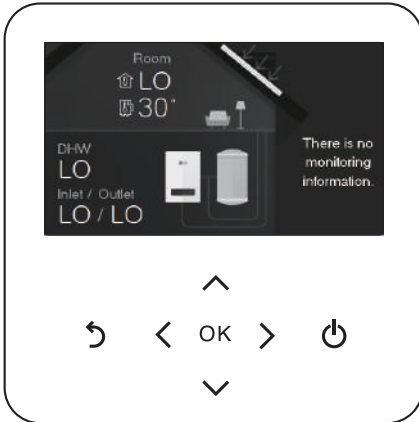

Mode	Description
Room temperature	View room temperature
Inlet temperature	View inlet temperature
Outlet temperature	View outlet temperature
DHW temperature	View DHW temperature (Only displayed when DHW heating mode)
Solar heat temperature	View solar power temperature (Only displayed when DHW water heating mode)

2nd circuit mode

(For Split)

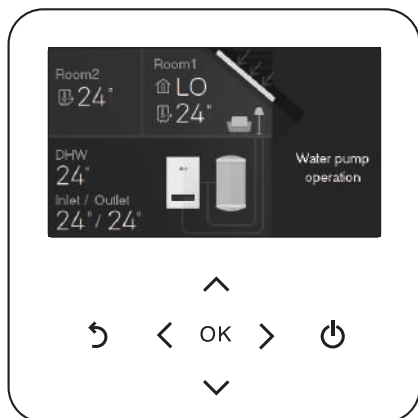

(For Hydrosplit)



Mode	Description
Room 1 temperature	View room 1 temperature
Room 2 temperature	View room 2 temperature
Inlet temperature	View inlet temperature
Outlet temperature	View outlet temperature
DHW temperature	View DHW temperature (Only displayed when DHW heating mode)
Solar heat temperature	View solar power temperature (Only displayed when DHW water heating mode)

LOCK SETTING

How to enter Lock setting

- In the menu screen, press [\left, \right] button to select “lock setting” category, and press [OK] button to move to the lock setting list screen.
- In the lock setting list, if you press [\wedge, \vee] button, you can turn on/off the corresponding lock function.

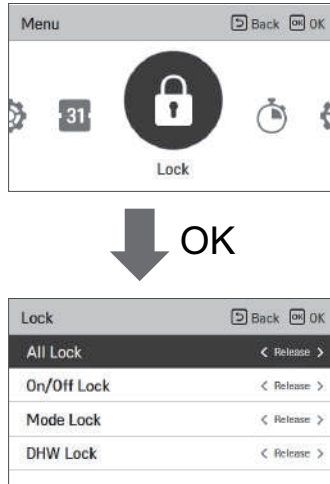

Lock setting – all, on/off, mode, DHW lock

- It is the function to lock the button operation of the remote controller so that children or other persons cannot use it without permission.
- It is the function to limit the desired temperature range that can be set in the wired remote controller.

Mode	Description
All Lock	It locks all button operation of the remote controller.
On/Off Lock	It locks the On/Off button operation of the remote controller.
Mode Lock	lock It locks the operation mode button operation of the remote controller
DHW Lock	lock It locks the DHW On/Off button operation of the remote controller.

NOTE

- DHW lock is not used when the DHW tank is not installed.
- If you want to know more information, refer function on installation information section.

NOTE

In the central controller, when the central control temperature range lock is set, the wired remote controller's temperature lock setting is cleared.

The temperature change by external equipment is reflected regardless of the remote controller temperature range lock.

TIMER SETTING

Timer entrance and setting method

- In the menu screen, press [**<**,**>**(left/right)] button to select the timer category, and press [OK] button to move to the timer setting list screen.
- In the timer setting list screen, press [**^**,**v** (up/down)] button to select the timer to set, and press [OK] button to move to the detail screen.
- After setting the value, when you press [OK] button, the timer is activated.
- After setting the value, if you press [Back] button, the changed value will not be applied.

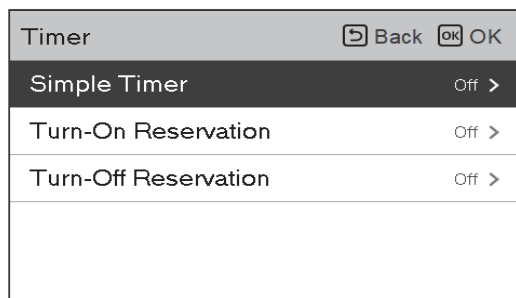
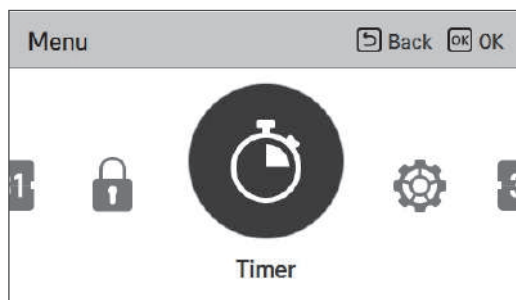

Simple Timer

You can easily set the timer in the range of 1~7 hours in the units of 1 hour.

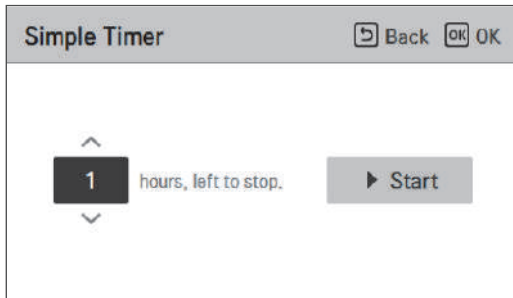
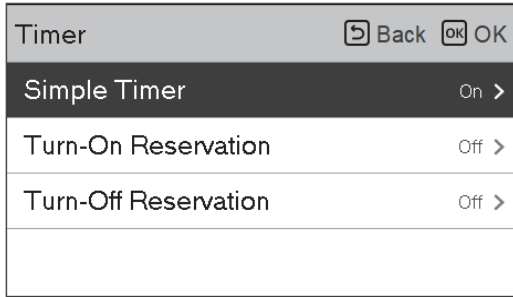

NOTE

If the product operation is On, the easy timer turns off the operation after the corresponding time.

If the product operation is Off, the easy timer turns on the operation after the corresponding time.

If the easy timer operation is turned On/Off before the timer operation, the set timer will be cleared.

Turn-On Reservation

The product is automatically turned On at the set timer time.

Timer	Back	OK
Simple Timer	Off	>
Turn-On Reservation	On	>
Turn-Off Reservation	Off	>

It provides 2 Time formats, 12Hours(AM/PM) or 24Hours reference.

Turn-On Reservation
Back OK

Minute
14 : 00

Start

Turn-On Reservation
Back OK

AM/PM
Minute
AM 12 : 00

Start

NOTE

Even if the Turn-on Reservation operation is turned On/Off after the setting and before the timer operation, the set timer is not cleared.

Turn-Off Reservation

The product is automatically turned Off at the set timer time.

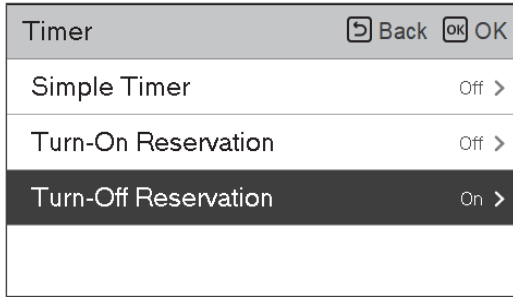

It provides 2 Time formats, 12 Hours(AM/PM) or 24 Hours reference.

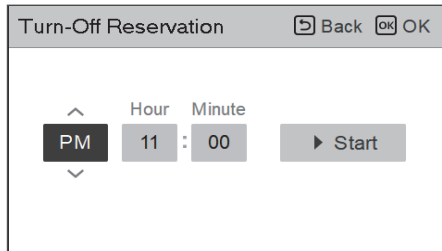
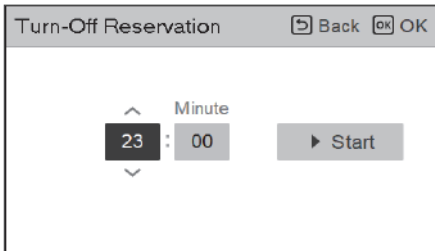

NOTE

Even if the Turn-off Reservation operation is turned On/Off after the setting and before the timer operation, the set timer is not cleared.

SCHEDULE SETTING

How to enter schedule

- In the menu screen, press [\leftarrow , \rightarrow] button so select the schedule category, and press [OK] button to move to the schedule setting list screen.
- In the schedule setting list screen, press [\wedge , \vee] (up/down) button to select the menu to set, and press [OK] button to move to the detail screen.
- There are 3 options in schedule formula ,depending on product function.
 - Room
 - Hot water
 - Heater of hot water tank

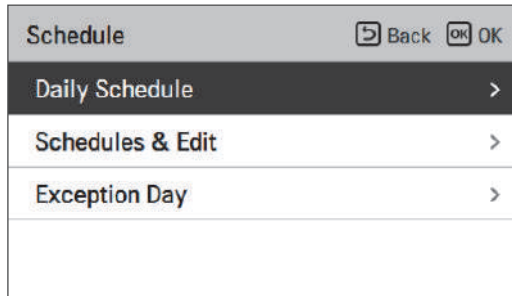
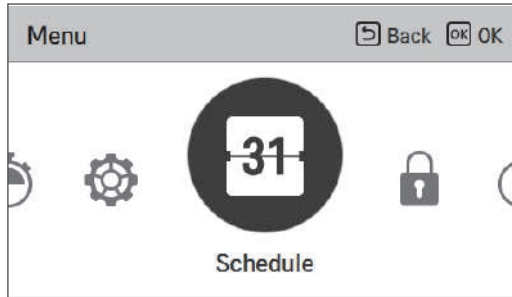

NOTE

Even though there is a heater of hot water tank schedule option, It cannot be activated in case of sterilization operation.

Daily schedule

It is the function that can check the status of the timer (schedule) saved in the remote controller.

- In the schedule list, select the daily schedule status category, and press [OK] button to move to the detail daily schedule status screen.
- You can use the remote controller's [<, > (left/right)] button to check the timer information of other dates.

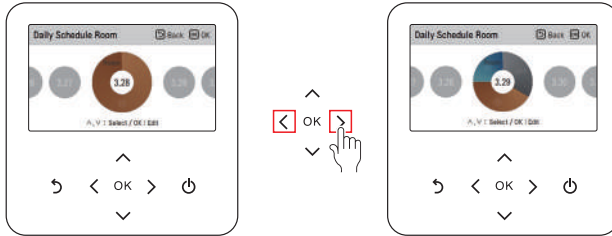

- You can use the remote controller's [^, v (up/down)] button to check the corresponding date's other timer information.

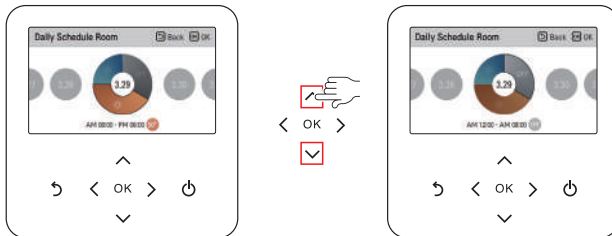

- Select the timer information, and press [OK] button to move to the corresponding timer's edit screen.

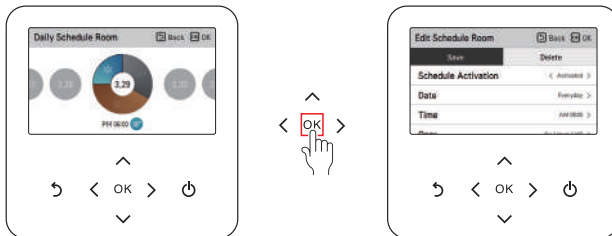

NOTE

In the daily schedule status screen, even if the timer (schedule) is set, if the corresponding date is designated as an exception date, the schedule will not be performed.

Less than 5 schedules per day is recommended.

Schedules & Edit

It is the function that can check the status of the timer (schedule) saved in the remote controller.

- In the schedule list, select the daily schedule status category, and press [OK] button to move to the daily schedule status detail screen.
- You can use the remote controller's [←,→(left/right)] button to check other date's timer information.

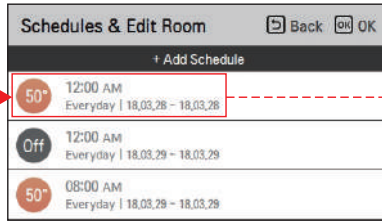

You can check the set timer's operation information (operation On/Off, operation mode, desired temperature), timer time, period, and day of week.

- You can edit the saved schedule's timer information.
 - Select the schedule to edit using [↑, ↓ (up/down)] button, and press [OK] button to move to the edit screen.

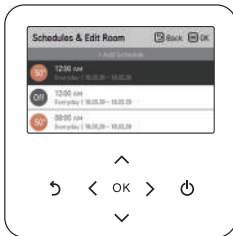

- Select the timer information, and press [OK] button to move to the corresponding timer's edit screen.

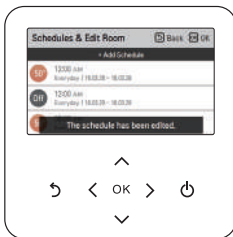

< If schedule is changed >



< If schedule is deleted >

Schedules & Edit – Add schedule

Description of each stage in Add schedule

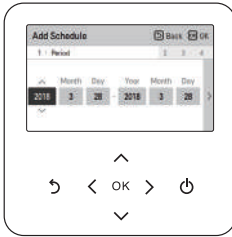

Stage 1. Period setting

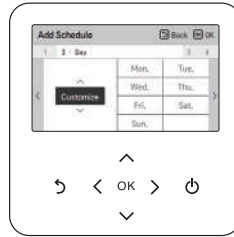

Stage 2. Day of week setting

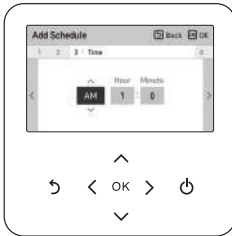

Stage 3. Time setting

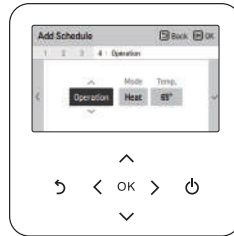

Stage 4. Operation setting

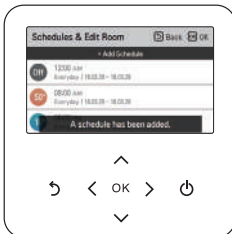

Add schedule is completed

In 'Stage 1', it sets the period to perform the timer.

In 'Stage 2', it sets the day of week to perform the timer.

- You can select 'Everyday / Weekend / Weekdays / Individual selection'.

In 'Stage 3', it sets the start time for the timer.

In 'Stage 4', it sets the timer operation information.

- If 'Stop' is selected, you cannot set the mode / temperature.

When stages 1~4 are completed, along with the message of 'schedule is added', it moves to View and edit schedule screen.

Exception Day

It is the function to automatically stop the operation on the set timer day.

- In the schedule list, select the exception day category, and press [OK] button to move to the Exception day designation detail screen.
- In the exception day, you can check, and add/change/delete the exception day information saved in the remote controller.
 - To add an exception day, in the Exception day registration detail screen, designate year/month/day, and press [OK] button to save the Exception day.
 - Select the Exception day to edit using [∧, ∨ (up/down)] button, and press [OK] button to move to the edit screen.

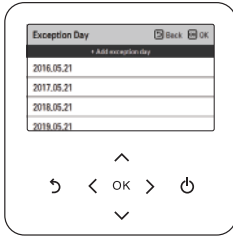

- In the exception day edit screen, you can check, delete/change the corresponding exception day's setting contents.
- When you change the exception day information, you need to save it after the change.

METER INTERFACE SETTING

Connection path of meter interface

It is the function that can check the status of energy and power on screen. It collects and calculates power or calorie data to create data for energy monitoring and energy warning alarm pop-ups. This function can be activated in installer mode.

Installer	Back	OK
3rd Party Boiler	>	
Meter Interface	>	
Pump Prerun/Overrun	>	
Data logging	>	
Recovery Initialization	>	

Meter Interface	Back	OK
Modbus Address	>	
Unit	>	



Modbus Address	Back	OK
Modbus Address	Not use	

Modbus Address	Back	OK
Modbus Address	B0	

Modbus Address	Back	OK
Modbus Address	B1	

There are 2 options, modbus address and unit, in this function. Activating the modbus address option, you choose one address(B0 or B1) or don't use. Then, you set the port and specification in range of 0000.0~9999.9[pulse/kWh] as shown in the figure below.

Unit	Back	OK
Pulse/kWh	Port1	0 0 0 0 . 0

Unit	Back	OK
Pulse/kWh	Port1	1 1 1 1 . 1

Information of meter interface

It provides useful information on the amount of energy and power during the week/month/year. Opening "Energy" option, these are presented on screen.

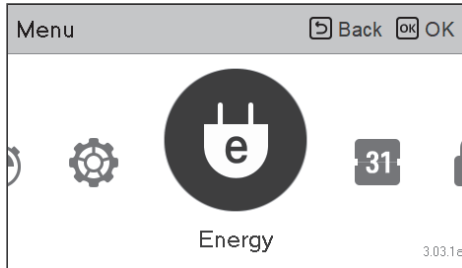

Instantaneous Power

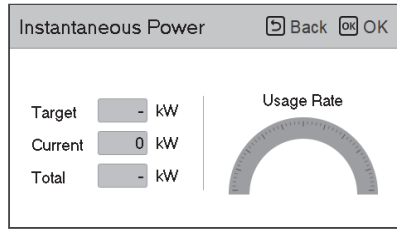
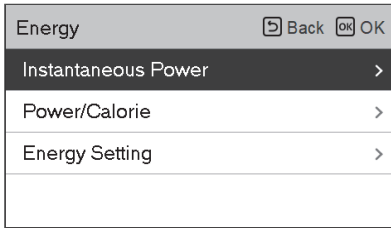

Power/Calorie

The information includes instantaneous power as well as power/calorie usage and up to annual trend.

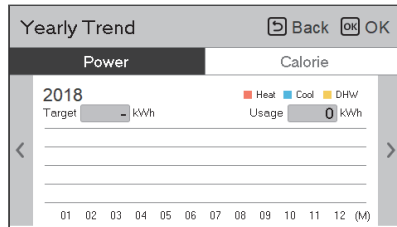
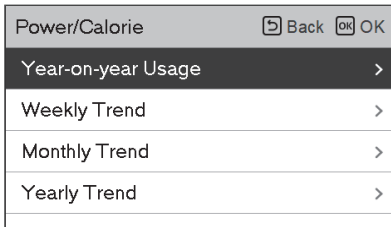

Energy Setting

In addition, various energy settings are possible as shown below.

Current value reaches to defined target value, It alerts to you on display

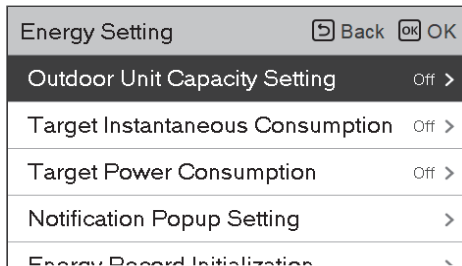

FUNCTION SETTING

How to enter function setting

To enter the menu displayed at the bottom, you need to enter the function setting menu as follows.

- In the menu screen, press [←,→](left/right) button to select the setting category, and press [OK] button to move to the setting list.
- In the setting list, select the function setting category, and press [OK] button to move to the function setting list.

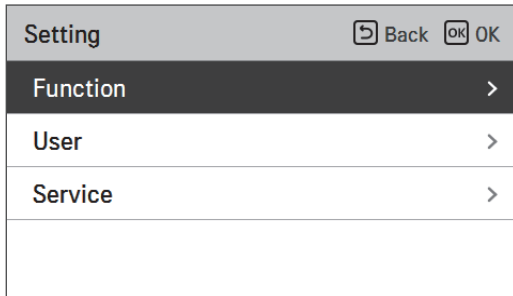
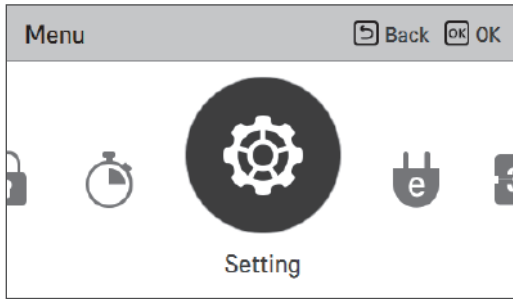

Function setting

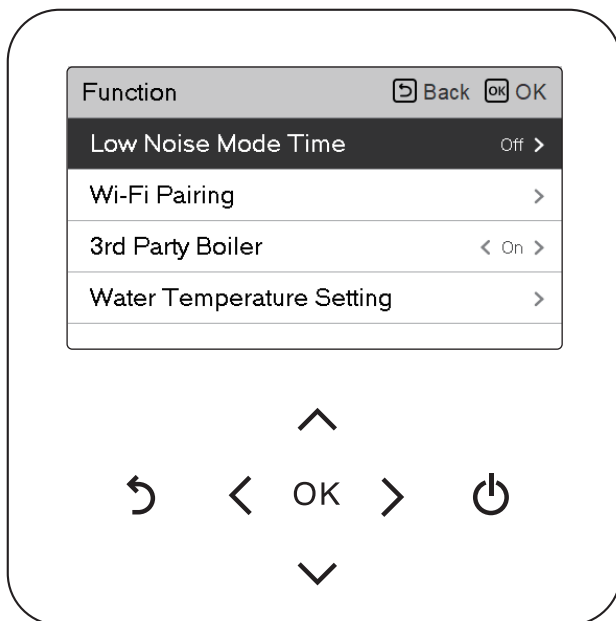

Menu	Description
Low Noise Mode Time	It is the function to set the start and end time of the outdoor unit's low noise mode operation.
Wi-Fi Pairing	It is the function to control remotely through network with indoor unit.
Water Temperature Setting	If you choose (Leaving/Inlet) water temperature control way, This option is activated on screen. It is the function to set target water temperature.
3 rd Party Boiler	It is the function to linkage the boiler of other companies. (this function can be activated, after setting every value in installer mode.)

Low Noise Mode Time

It is the function to set the start and end time of the outdoor unit's low noise mode operation.

- In the function setting list, select the Low Noise Mode Time category, and press [OK] button to move to the detail screen.
 - After setting the start time and the end time, press [OK] button to move to the upper level list.
 - If the start time and the current time are the same, it enters the outdoor unit low noise operation mode, and in the monitoring screen, 'in outdoor unit low noise operation mode' message is displayed.
 - If the end time and the current time are the same, the outdoor unit low noise operation mode is cleared.

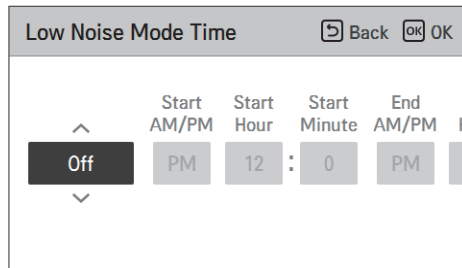
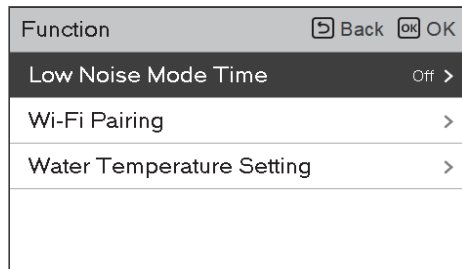

NOTE

Low noise mode time setting function can be set only when the installer setting's outdoor unit function M/S setting is set to "Master".

Low noise mode time setting function is only available in some products.



CAUTION

If the function is not used, please set it to Off.

When you enter the low noise operation, the cooling capacity may be degraded.

Wi-Fi Pairing

It is the function to control remotely through network with indoor unit.

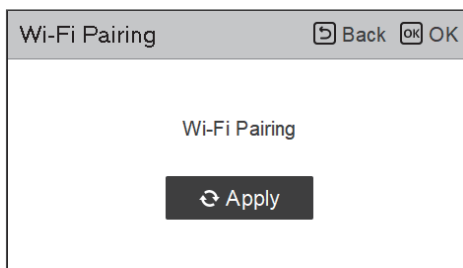
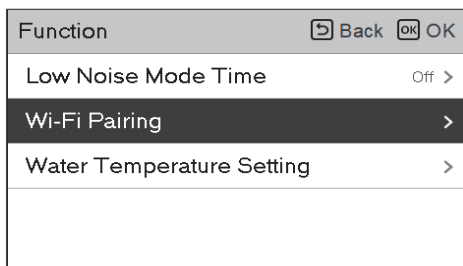

Water Temperature Setting

NOTE

This function is not default.
It can be activated, after setting value in installer mode.

If you choose air+water temperature control way, This option is listed-up on function setting display. It is the function to set target water temperature.

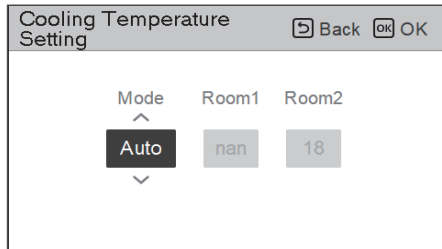
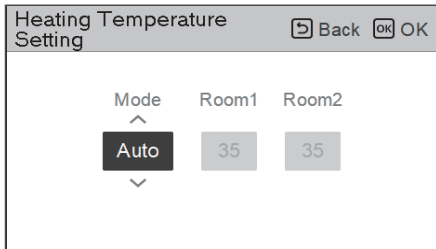
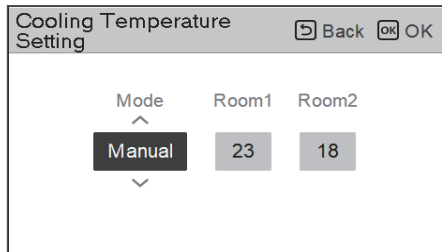
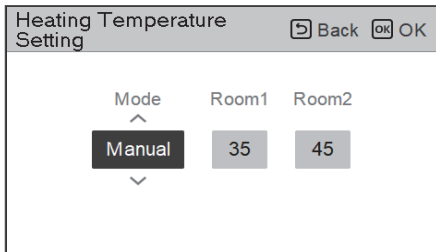
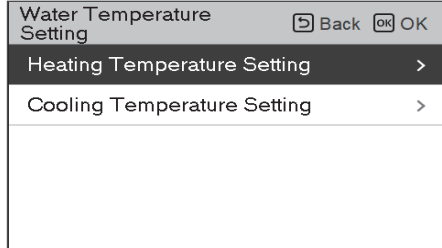
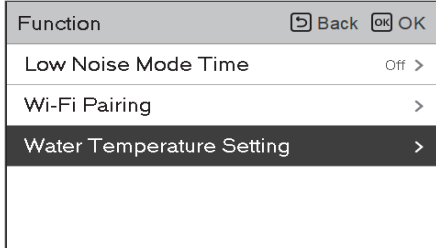

3rd Party Boiler

NOTE

This function is not default.

It can be activated, after setting value in installer mode.

Function to set whether or not to use a installed 3rd Party function.

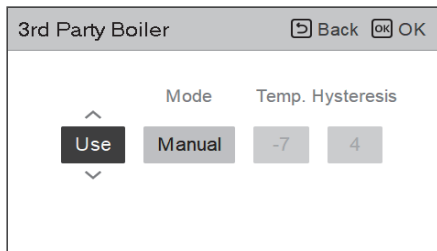
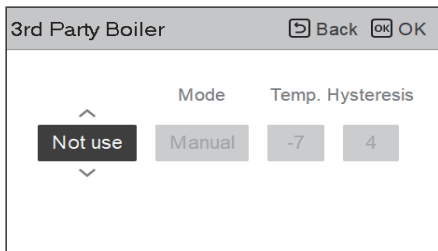

If the mode of this function is set to "Manual", you can set temperature of the boiler and hysteresis, respectively.

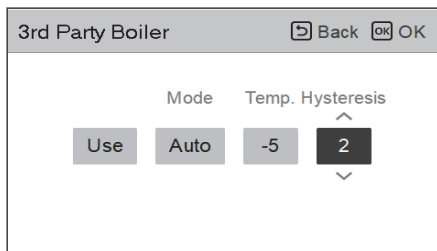
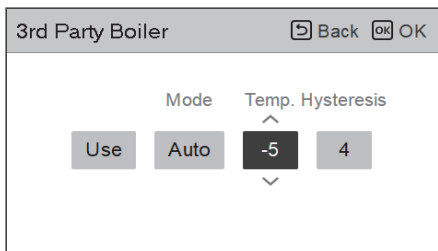

As shown above, After every setting is completed in installer mode, 3rd party boiler option is activated in function list.

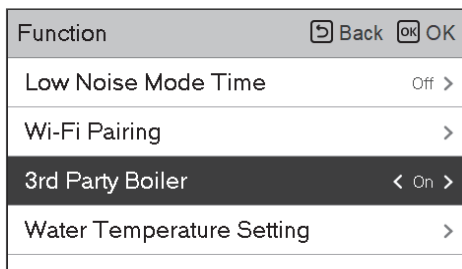

On/off mode of this option are opened by pushing "<" or ">" button simply and easily.

USER SETTING

How to enter user setting

To enter the menu displayed at the bottom, you need to enter the user setting menu as follows.

- Select the setting category, and press [OK] button to move to the setting list.
- Select the user setting category, and press [OK] button to move to the user setting list.

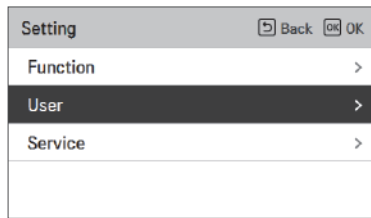
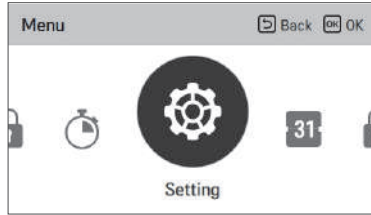

User Setting

- You can set the product user functions.
- Some functions may not be available in some product types.

Menu	Description
Language	Set the language to be displayed on the remote controller.
Temperature Unit	Set the temperature unit displayed on the remote controller.
Screen Saver Timer	Adjust the screen Off time of the remote controller.
LCD Brightness In Idle	Adjust the remote controller's screen brightness.
Date	Set the date displayed on the remote controller.
Time	Set the time displayed on the remote controller.
Summer Time	Set the summer time in the remote controller.
Password	Set the password to prevent unauthorized change to remote controller settings.
Schedule Initialization	Initialize all timer settings in the remote controller.
Theme	Set the theme of the remote controller screen.
System Reboot	Restart the remote controller.

Language

Set the language to be displayed on the remote controller.

- In the user setting list, select the language category, and press [OK] button to move to the detail screen.
- After the setting, if you press [OK] button, the setting is saved and moves to the previous screen.

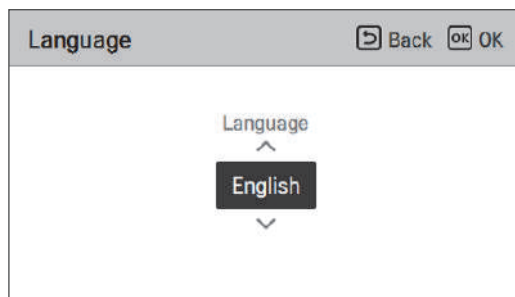
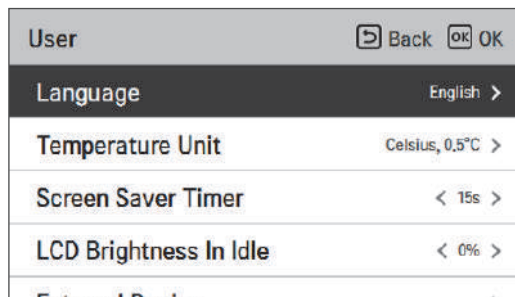

Language		
한국어	English	Français
Deutsche	Italiano	Español
Русский	Polski	Português
中国	Čeština	Türk
Nederlands	Românesc	ελληνικά
Magyar	Български	Srpski
Hrvatski	Slovenščina	

Temperature Unit

Set the temperature unit displayed on the remote controller.

- In the user setting list, select the temperature unit setting category, and press [OK] button to move to the detail screen.

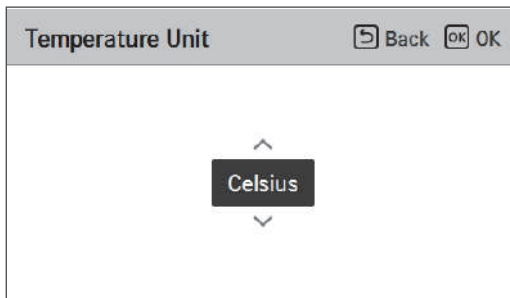
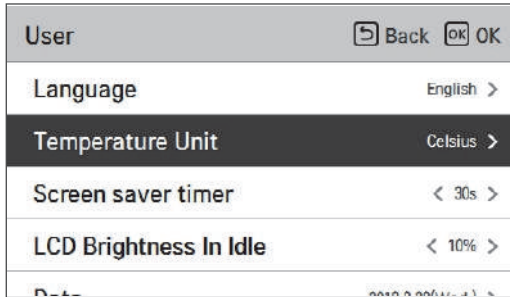

Value	Celsius
	Fahrenheit

CAUTION

The temperature unit function may not work or work differently in some products.
You cannot set the temperature unit in the slave wired remote controller.

Screen Saver Timer

Adjust the screen Off time of the remote controller.

- Select the following setting values using [\leftarrow , \rightarrow](left/right) button.

User	Back	OK
Language	English	>
Temperature Unit	Celsius, 0.5°C	>
Screen Saver Timer	<	15s >
LCD Brightness In Idle	<	0% >
External Device		>

Value		
15 seconds	30 seconds (default)	1 minute

! CAUTION

Selecting longer stand by screen will decrease LCD lifespan.

LCD Brightness In Idle

Adjust the remote controller's screen brightness.

- Select the following setting values using [\leftarrow , \rightarrow](left/right) button.

User	Back	OK
Language	English	>
Temperature Unit	Celsius, 0.5°C	>
Screen Saver Timer	<	15s >
LCD Brightness In Idle	<	0% >
External Device		>

Value			
0 %	10 % (default)	20 %	30 %

! CAUTION

Selecting brighter stand by screen will decrease LCD lifespan.

Date

Set the date displayed on the remote controller.

- In the user setting list, select the date category, and press [OK] button to move to the detail screen.
- After the setting, if you press [OK] button, the setting is saved and moves to the previous screen.

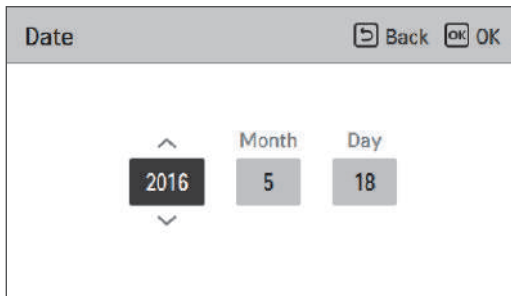
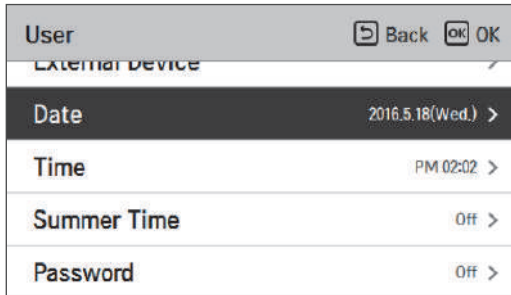

Time

Set the time displayed on the remote controller.

- In the user setting list, select the time category, and press [OK] button to move to the detail screen.
- After the setting, if you press [OK] button, the setting is saved and moves to the previous screen.
- In the screen, Time display can be presented in the form of AM / PM or 24 hours standard.

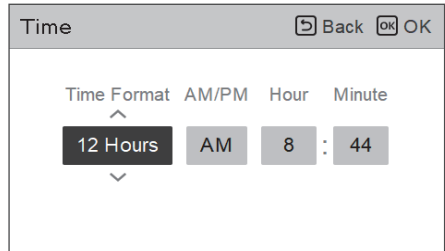
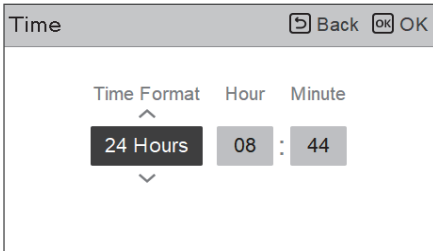
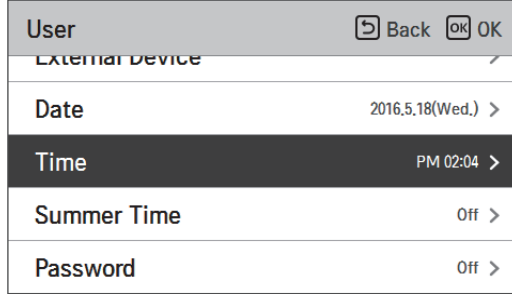

Summer Time

Set the daylight savings time dates in the remote controller.

- In the user setting list, select the summer time setting category, and press [OK] button to move to the detail screen.
 - Summer time: The system to advance the time by 1 hour from the spring when the day is longer and return back in the fall when the day gets shorter.
 - When it becomes AM 02:00 on the DST start date, the current time changes to AM 03:00, and when it becomes AM 02:00 of the DST end date, the current time changes to AM 01:00.

The screenshot shows a menu titled 'User' with a 'Back' button and an 'OK' button. The menu items are: 'External Device', 'Date' (2016,5,18(Wed.)), 'Time' (PM 02:05), 'Summer Time' (Off), and 'Password' (Off). The 'Summer Time' item is highlighted with a dark background.



The screenshot shows the 'Summer Time' detail screen with a 'Back' button and an 'OK' button. The current setting is 'Off'. Below this, there are two date pickers: 'Month Day' and 'Month Day'. The first date picker shows '1' for both month and day. The second date picker also shows '1' for both month and day. A hyphen '-' is placed between the two date pickers.

Password

Set the password to prevent unauthorized change to remote controller settings.

- Select the user password setting category, and press [OK] button to move to the detail screen.
 - If the password is set, when you enter "menu – setting", you need to input password to enter the setting list.
 - When you forgot the password, you can initialize the password using the installer setting's "password initialization".
The initialized password is "0000".

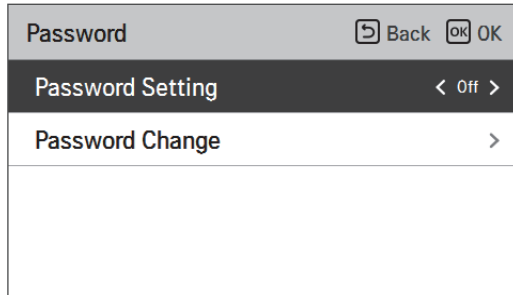
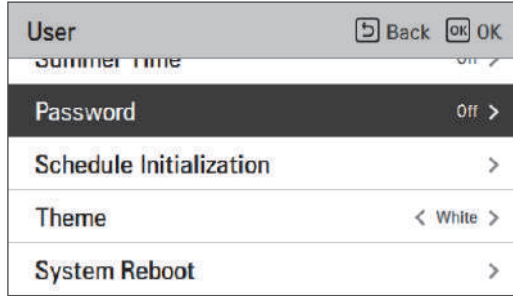

Schedule Initialization

Initialize all timer settings in the remote controller.

- In the user setting list, select the schedule initialization setting category, and press [OK] button to move to the detail screen.
 - Press the check button to initialize the sleep/simple timer, on/off timer, schedule and exception date in the remote controller.

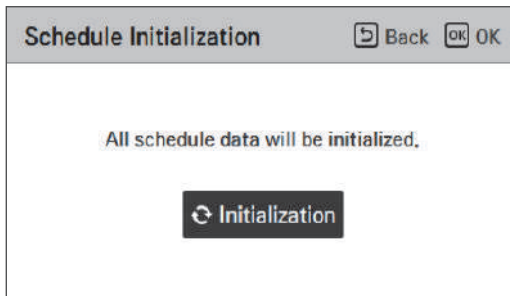
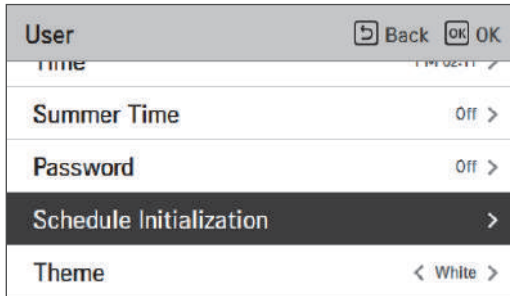

Theme

Set the theme of the remote controller screen.

- Select either white or black using [<,>(left/right)] button.

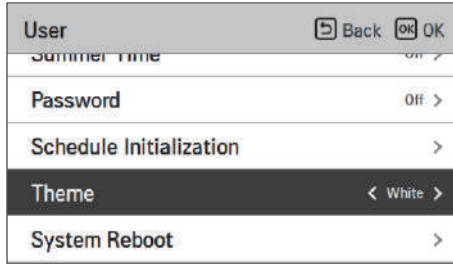

System Reboot

Restart the remote controller.

- In the user setting list, select the system restart setting category, and press [OK] button to move to the detail screen.
 - In the detail screen, when you press [OK] button, a popup message is displayed, press the check button, to restart the system.
 - For forced reset, press down [On/Off + Back] button for 5 seconds to restart the system.

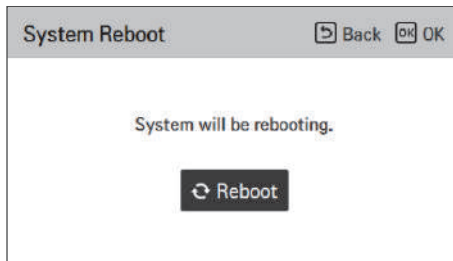
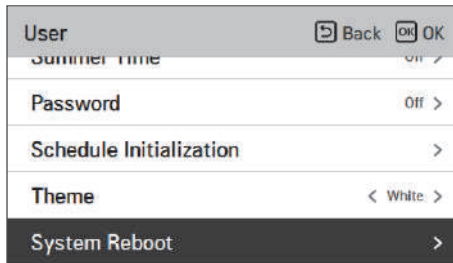

OVERVIEW OWNER'S SETTINGS

Menu structure

Menu		
→	Lock	
→	All Lock27
→	On/Off Lock27
→	Mode Lock27
→	Timer	
→	Simple Timer29
→	Turn-On Reservation30
→	Turn-Off Reservation31
→	Schedule	
→	Daily Schedule33
→	Schedules & Edit34
→	Exception Day36
→	Energy	
→	Connection path of meter interface37
→	Information of meter interface38
→	Instantaneous Power38
→	Power/Calorie38
→	Energy Setting38
→	Setting	
→	Function	
→	Low Noise Mode Time41
→	Wi-Fi Pairing42
→	Water Temperature Setting43
→	3 rd Party Boiler44

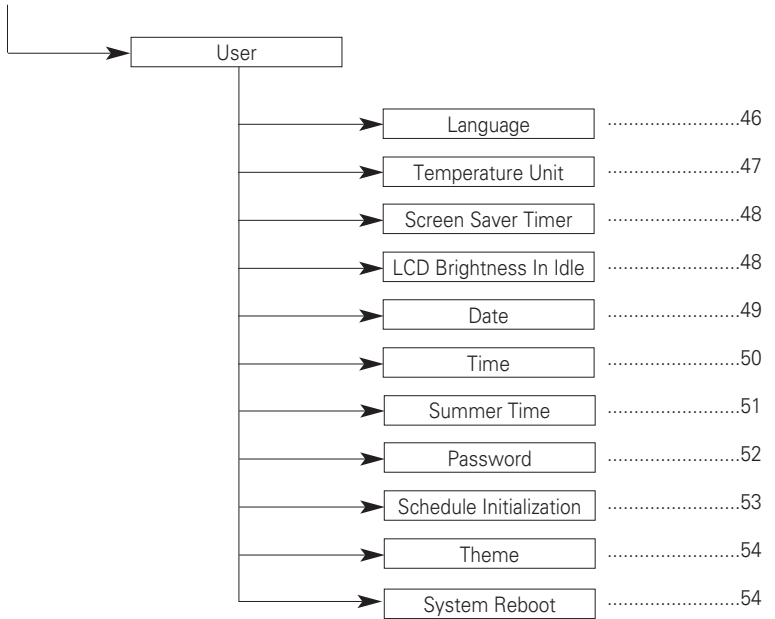

USING THERMOSTAT

The term "thermostat", which is widely used in this chapter, is a kind of 3rd party accessory. LG Electronics does not supply thermostat and it should be supplied 3rd party manufacturers.

Room thermostat can be used for easy and convenience control. To utilize thermostat more efficiently and correctly, this chapter presents information about using thermostat.

When thermostat is interlocked, the subject of Thermo On / Off is limited to the thermostat



CAUTION

- Some electro-mechanical type thermostat has internal delay time to protect compressor. In that case, mode change can takes time more than user's expectation. Please read thermostat manual carefully if the product does not response quickly.
- Setting temperature range by thermostat can be different with that of the product. The heating or cooling set temperature should be chosen within the setting temperature range of the product.

How to use thermostat

To find how to turn on and off, how to set target temperature, how to change operating mode, etc, please refer thermostat operating manual provided by thermostat manufacturer.

EMERGENCY OPERATION

• Definition of terms

- Trouble : a problem which can stop system operation, and can be resumed temporarily under limited operation without certificated professional's assist.
- Error : problem which can stop system operation, and can be resumed only after certificated professional's check.
- Emergency mode : temporary heating operation while system met trouble.

• Objective of introducing 'Trouble'

- Not like airconditioning product, Air-to-Water heat pump is generally operation in whole winter season without any system stopping.
- If system found some problem, which is not critical to system operating for yielding heating energy, the system can temporarily continue in emergency mode operation with end user's decision.

• Classified trouble

- Trouble is classified two levels according to the seriousness of the problem. : Slight trouble and Heavy trouble
- Slight trouble : Sensor trouble. In most case, this trouble is concerned with sensor problems. The unit is operating under emergency mode operation(level 1).
- Heavy trouble : Compressor cycle trouble. Emergency mode operation(level 2) is performed by optional electric heater.
- Option trouble : a problem is found for option operation such as water tank heating. In this trouble, the troubled option is assumed as if it is not installed at the system.

• Emergency operation level

When the AWHP has any trouble,

- (1) If there is not a function to judge possibility of operation : Once an error occurs mainly in indoor unit, AWHP stops. On the other hand, Remocon allows the product to activate On / Off operation.(On : emergency operation)
 - Slight / Heavy trouble : Heating Operable only
 - Critical trouble : Full stop
 - Treatment priority : Critical > Heavy > Slight
- (2) If there is a function to judge possibility of operation : Depending on the status of slight / heavy / critical trouble, pop-up phrase is guided separately on display.
 - Slight trouble : Heating / Cooling Operable
 - Heavy trouble : Heating Operable only
 - Critical trouble : Service center request
 - AWHP operates when user pressed OK button on pop-up window.

- **Duplicated trouble : Option trouble with slight or heavy trouble**

- If option trouble is occurred with slight (or heavy) trouble at the same time, the system puts higher priority to slight (or heavy) trouble and operates as if slight (or heavy) trouble is occurred.
- Therefore, sometimes sanitary water heating can be impossible in emergency operation mode. When sanitary water is not warming up while emergency operation, please check if sanitary water sensor and related wiring are all Ok.

- **Emergency operation is not automatically restarted after main electricity power is reset.**

- In normal condition, the product operating information is restored and automatically restarted after main electricity power is reset.
- But in emergency operation, automatic re-start is prohibited to protect the product.
- Therefore, user must restart the product after power reset when emergency operation has been running.

MAINTENANCE AND SERVICE

Maintenance activities

In order to ensure optimal availability of the unit, a number of checks and inspections on the unit and the field wiring have to be carried out at regular intervals, preferably yearly. This maintenance should be carried out by your local agreed technician.

When the unit is not going....

⚠ CAUTION

- If the product is not used for long time, we strongly recommend not to switch off the power supply to the product.
- When the power is applied for the first time, operate the product after preheating for 2 hours. To protect the unit by increasing the oil temperature of the compressor.
- If power is not supplied, some special product-protecting actions (such as water pump anti-locking) will not performed.

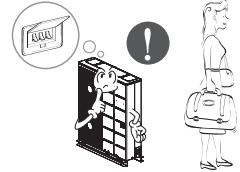

Call the service immediately in the following situations

- Anything abnormal such as burning smell, loud noise etc. happen. Stop the unit and turn the breaker off. Never try to repair by yourself or restart the system in such cases.
- Main power cord is too hot or damaged.
- Error code is generated by self diagnosis.
- Water leaks from unit.
- Any switch, breaker (safety, earth) or fuse fails to work properly.

User must carry routine checkup & cleaning to avoid unit's poor performance.

In case of special situation, the job must be carried out by the only service person.

⚠ CAUTION

- In the case of water with added brine, the drain valve of shut-off valve must be connected to a recovery container.
- Do not touch the water stirred with the brine.
- When the brine in the pipe is leaked, do not operate the unit and contact dealer, seller or an authorized service center.



Eco design requirement

· The information for Eco design is available on the following free access website.
<http://www.lg.com/global/support/cedoc/cedoc>