

INSTALLATION MANUAL

AIR CONDITIONER

Please read this installation manual completely before installing the product. Installation work must be performed in accordance with the national wiring standards by authorized personnel only. Please retain this installation manual for future reference after reading it thoroughly.

Single Inverter Outdoor Unit Original instruction (R32)

[Representative] LG Electronics Inc. Single Point of Contact (EU/UK) & EU Importer :

LG Electronics European Shared Service Center B.V. Krijgsman 1, 1186 DM Amstelveen, The Netherlands

[HQ Manufacturer] LG Electronics Inc. Changwon 2nd factory 84, Wanam-ro, Seongsan-gu, Changwon-si, Gyeongsangnam-do, KOREA

[TA Manufacturer] LG Electronics Tianjin Appliances co.,Ltd.
No.09,Jinwei Road,Beichen District,Tianjin,China.



MFL71675701
Rev.01_211203

Copyright © 2019 - 2021 LG Electronics Inc. All Rights Reserved.

www.lg.com

ENGLISH

ITALIANO

ESPAÑOL

FRANÇAIS

DEUTSCH

ΕΛΛΗΝΙΚΑ

ČEŠTINA

NETERLANDS

POLSKI

LIMBA ROMÂNĂ

MODEL DESIGNATION

Product information

- Product Name : Air conditioner

- Model Name :

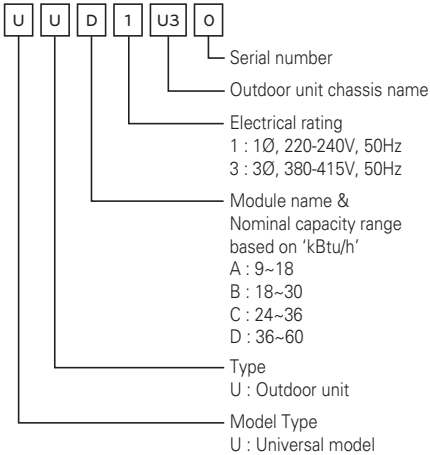

- Additional Information : serial number is refer to the barcode on the product.

- Max allowable pressure High side : 4.2 MPa / 4.32 MPa (it can be different by model)

- Max allowable pressure Low side : 2.4 MPa

- Refrigerant : R32

Airborne Noise Emission

The A-weighted sound pressure emitted by this product is below 70 dB.

** The noise level can vary depending on the site.

The figures quoted are emission level and are not necessarily safe working levels.

Whilst there is a correlation between the emission and exposure levels, this cannot be used reliably to determine whether or not further precautions are required.

Factor that influence the actual level of exposure of the workforce include the characteristics of the work room and the other sources of noise, i.e. the number of equipment and other adjacent processes and the length of time for which an operator exposed to the noise. Also, the permissible exposure level can vary from country to country.

This information, however, will enable the user of the equipment to make a better evaluation of the hazard and risk.

TIPS FOR SAVING ENERGY

Here are some tips that will help you minimize the power consumption when you use the air conditioner. You can use your air conditioner more efficiently by referring to the instructions below:

- Excessive cooling may be harmful to your health and may consume more electricity.
- Block sunlight with blinds or curtains while you are operating the air conditioner.
- Keep doors or windows closed while you are operating the air conditioner.
- Adjust the direction of the air flow vertically or horizontally to circulate indoor air.
- Speed up the fan to cool or warm indoor air quickly, in a short period of time.
- Open windows regularly for ventilation as the indoor air quality may deteriorate if the air conditioner is used for many hours.
- Clean the air filter once every 2 weeks. Dust and impurities collected in the air filter may block the air flow or weaken the cooling / dehumidifying functions.

For your records

Staple your receipt to this page in case you need it to prove the date of purchase or for warranty purposes. Write the model number and the serial number here:

Model number : _____





Serial number : _____

You can find them labeled on the side of each unit.

Dealer's name : _____

Date of purchase : _____

IMPORTANT SAFETY INSTRUCTIONS

	Read the precautions in this manual carefully before operating the unit.		This appliance is filled with flammable refrigerant. (for R32)
	This symbol indicates that the Operation Manual should be read carefully.		This symbol indicates that a service person should be handling this equipment with reference to the Installation Manual.

READ ALL INSTRUCTIONS BEFORE USING THE APPLIANCE.

Always comply with the following precautions to avoid dangerous situations and ensure peak performance of your product.

⚠ WARNING

Serious injury or death can result if directions are ignored.

⚠ CAUTION

Minor injury or product damage can result if directions are ignored.

⚠ WARNING

- Installation or repairs made by unqualified persons can result in hazards to you and others.
Refrigeration work must be performed by a qualified person who is "F-Gas" registered.
- Installation work must be performed in accordance with the National Electric Code by qualified and authorized personnel only.
- The information contained in the manual is intended for use by a qualified service technician familiar with safety procedures and equipped with the proper tools and test instruments.

- Failure to carefully read and follow all instructions in this manual can result in equipment malfunction, property damage, personal injury and/or death. (for R32)
- Compliance with national gas regulations shall be observed

Installation

- Do not use a defective or underrated circuit breaker. Use the correctly rated breaker and fuse. There is risk of fire or electric shock.
- For electrical work, contact the dealer, seller, a qualified electrician, or an Authorized Service Center. Do not disassemble or repair the product by yourself. There is risk of fire or electric shock.
- Always ground the product as per the wiring diagram. Do not connect the ground wire to gas or water pipes lightning rod or telephone ground wire. There is risk of fire or electric shock.
- Install the panel and the cover of control box securely. There is risk of fire or electric shock due to dust , water etc.
- Use the correctly rated breaker or fuse. There is risk of fire or electric shock.
- Do not modify or extend the power cable. If power cable is damaged or has deteriorated, then it must be replaced. There is risk of fire or electric shock.
- For installation, removal or reinstall , always contact the dealer or an Authorized Service Center. There is risk of fire, electric shock, explosion, or injury.
- Do not install the product on a defective installation stand. Be sure that the installation area does not deteriorate with age. It may cause product to fall.

- Never install the outdoor unit on a moving base or a place from where it can fall down.
The falling outdoor unit can cause damage or injury or even death of a person.
- In outdoor unit the step-up capacitor supplies high voltage electricity to the electrical components. Be sure to discharge the capacitor completely before conducting the repair work. A charged capacitor can cause electrical shock.
- When installing the unit, use the installation kit provided with the product. Otherwise the unit may fall and cause severe injury.
- Indoor/outdoor wiring connections must be secured tightly and the cable should be routed properly so that there is no force pulling the cable from the connection terminals. Improper or loose connections can cause heat generation or fire.
- Safely dispose off the packing materials. Like screws, nails, batteries, broken things etc after installation or svc and then tear away and throw away the plastic packaging bags. Children may play with them and cause injury.
- Be sure to check the refrigerant to be used. Please read the label on the product. Incorrect refrigerant used can prevent the normal operation of the unit.
- Do not turn on the breaker or power under condition that front panel, cabinet, top cover, control box cover are removed or opened. Otherwise, it may cause fire, electric shock, explosion or death.
- Use a vacuum pump or Inert (nitrogen) gas when doing leakage test or air purge. Do not compress air or Oxygen and do not use Flammable gases. Otherwise, it may cause fire or explosion.
 - There is the risk of death, injury, fire or explosion.

- The appliance shall be stored in a room without continuously operating ignition sources (for example: open flames, an operating gas appliance or an operating electric heater)
- Do not use means to accelerate the defrosting process or to clean, other than those recommended by the manufacturer.
- Do not pierce or burn refrigerant cycle part.
- Be aware that refrigerants may not contain an odour.
- Keep any required ventilation openings clear of obstruction.
- The appliance shall be stored in a well-ventilated area where the room size corresponds to the room area as specified for operation. (for R32)
- The appliance should only be transported by two or more people holding the appliance.
- Mechanical connections shall be accessible for maintenance purposes.
- The appliance shall be disconnected from its power source during service and when replacing parts.
- The appliance shall be installed in accordance with national wiring regulations.

Operation

- When the product is soaked (flooded or submerged) in water, contact an Authorized Service Center for repair before using it again. There is risk of fire or electric shock.
- Be sure to use only those parts which are listed in the svc parts list. Never attempt to modify the equipment. The use of inappropriate parts can cause an electrical shock, excessive heat generation or fire.
- Do not touch , operate, or repair the product with wet hands. Hold the plug by hand when taking it out. There is risk of electric shock or fire.

- Do not place a heater or other heating appliances near the power cable. There is risk of fire and electric shock.
- Do not allow water to run into electric parts. Install the unit away from water sources. There is risk of fire, failure of the product, or electric shock.
- Do not store or use or even allow flammable gas or combustibles near the product. There is risk of fire.
- Do not use the product in a tightly closed space for a long time. Perform ventilation regularly. Oxygen deficiency could occur and hence harm your health.
- Do not open the front grille of the product during operation. (Do not touch the electrostatic filter, if the unit is so equipped.) There is risk of physical injury, electric shock, or product failure.
- If strange sound, smell or smoke comes from product. Immediately turn the breaker off or disconnect the power supply cable. There is risk of electric shock or fire.
- Ventilate the product room from time to time when operating it together with a stove, or heating element etc. Oxygen deficiency can occur and hence harm your health.
- When the product is not to be used for a long time, disconnect the power supply plug or turn off the breaker. There is risk of product damage or failure, or unintended operation.
- Take care to ensure that nobody especially kids could step on or fall onto the outdoor unit. This could result in personal injury and product damage.
- Take care to ensure that power cable could not be pulled out or damaged during operation. There is risk of fire or electric shock.
- Do not place ANYTHING on the power cable. There is risk of fire or electric shock.

- When flammable gas leaks, turn off the gas and open a window for ventilation before turning on the product. Do not use the telephone or turn switches on or off. There is risk of explosion or fire.
- Keep any required ventilation openings clear of obstruction
- Turn off all devices that cause fire when the refrigerant leaks., ventilate the room (example : opening the window or using the ventilation), and contact with dealer who you purchased the unit.

CAUTION

Installation

- Two or more people must lift and transport the product. Avoid personal injury.
- Do not install the product where it will be exposed to sea wind (salt spray) directly. It may cause corrosion on the product.
- Install the drain hose to ensure that the condensed water is drained away properly. A bad connection may cause water leakage.
- Keep level even when installing the product. To avoid vibration or noise.
- Do not install the product where the noise or hot air from the outdoor unit could damage or disturb the neighborhoods. It may cause a problem for your neighbors and hence dispute.
- Always check for gas (refrigerant) leakage after installation or repair of product. Low refrigerant levels may cause failure of product.
- Please install safely at a place that can sufficiently endure the weight of the product.
If the strength is not sufficient, the product may fall and cause injury.

- Any person who is involved with working on or breaking into a refrigerant circuit should hold a current valid certificate from an industry-accredited assessment authority, which authorizes their competence to handle refrigerants safely in accordance with an industry recognized assessment specification. (for R32)
- Wear adequate personal protection equipment (PPE) when installing, maintaining or servicing the product.
- This appliance is not intended for use by persons (including children) with reduced physical, sensory or mental capabilities or lack of experience and knowledge, unless they have been given supervision or instruction concerning use of the appliance by a person responsible for their safety. Children should be supervised to ensure that they do not play with the appliance.
- Pipe-work shall be protected from physical damage.
- Do not install the unit in potentially explosive atmospheres.

Operation

- Do not use the product for special purposes, such as preserving foods, works of art, etc. It is a consumer air conditioner, not a precision refrigeration system. There is risk of damage or loss of property.
- Do not block the inlet or outlet of air flow. It may cause product failure.
- Use a soft cloth to clean. Do not use harsh detergents, solvents or splashing water etc. There is risk of fire, electric shock, or damage to the plastic parts of the product.
- Do not touch the metal parts of the product when removing the air filter. There is risk of personal injury.
- Do not step on or put anything on the product. (outdoor units) There is risk of personal injury and failure of product.

- Always insert the filter securely after cleaning. Clean the filter every two weeks or more often if necessary. A dirty filter reduces the efficiency.
- Do not insert hands or other objects through the air inlet or outlet while the product is operating. There are sharp and moving parts that could cause personal injury.
- Be cautious when unpacking and installing the product. Sharp edges could cause injury.
- If the refrigerant gas leaks during repair, do not touch the leaking refrigerant gas. The refrigerant gas can cause frostbite (cold burn).
- Do not tilt the unit when removing or uninstalling it. The condensed water inside can spill.
- Do not mix air or gas other than the specified refrigerant used in the system. If air enters the refrigerant system, an excessively high pressure results, causing equipment damage or injury.
- If the refrigerant gas leaks during the installation, ventilate the area immediately. Otherwise it can be harmful for your health.
- Dismantling the unit, treatment of the refrigerant oil and eventual parts should be done in accordance with local and national standards.
- Replace all batteries in the remote control with new ones of the same type. Do not mix old and new batteries or different types of batteries. There is risk of fire or product failure.
- Do not recharge or disassemble the batteries. Do not dispose off batteries in a fire. They may burn or explode.
- If the liquid from the batteries gets onto your skin or clothes, wash it well with clean water. Do not use the remote if the batteries have leaked. The chemicals in batteries could cause burns or other health hazards.

- If you eat the liquid from the batteries, brush your teeth and see doctor. Do not use the remote if the batteries have leaked. The chemicals in batteries could cause burns or other health hazards.
- Do not let the air conditioner run for a long time when the humidity is very high and a door or a window is left open. Moisture may condense and wet or damage furniture.
- Do not expose your skin or kids or plants to the cool or hot air draft. This could harm to your health.
- Do not drink the water drained from the product. It is not sanitary and could cause serious health issues.
- Use a firm stool or ladder when cleaning, maintaining or repairing the product at height. Be careful and avoid personal injury.
- The appliance shall be stored so as to prevent mechanical damage from occurring.
- Servicing shall only be performed as recommended by the equipment manufacturer. Maintenance and repair requiring the assistance of other skilled personnel shall be carried out under the supervision of the person competent in the use of flammable refrigerants. (for R32)
- This appliance can be used by children aged from 8 years and above and persons with reduced physical, sensory or mental capabilities or lack of experience and knowledge if they have been given supervision or instruction concerning use of the appliance in a safe way and understand the hazards involved. Children shall not play with the appliance. Cleaning and user maintenance shall not be made by children without supervision.
- Means for disconnection must be incorporated in the fixed wiring in accordance with the wiring rules.

TABLE OF CONTENTS

2 MODEL DESIGNATION

3 TIPS FOR SAVING ENERGY

4 IMPORTANT SAFETY INSTRUCTIONS

14 INSTALLATION

15 INSTALLATION OF OUTDOOR UNIT

21 CONNECTING PIPES

21 Preparation of Piping

22 Connection of piping - Outdoor

23 Forming the piping

24 WIRING CONNECTION

24 Electrical Wiring

24 Connecting Cables between Indoor Unit and Outdoor Unit

27 Connecting the cable to Outdoor Unit

28 LEAKAGE TEST AND EVACUATION

28 Preparation

28 Leakage test

29 Evacuation

30 TEST RUNNING

32 INSTALLATION PI485

33 FUNCTION

33 DIP S/W Setting

35 Pump Down

36 Saving Power Consumption

37 Night Quiet Mode









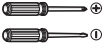

38 Mode Lock

40 INSTALLATION GUIDE AT THE SEASIDE

41 SEASONAL WIND AND CAUTIONS IN WINTER

INSTALLATION

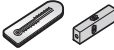
Installation Tools

Figure	Name	Figure	Name
	Screw driver		Multi-meter
	Electric drill		Hexagonal wrench
	Measuring tape, Knife		Ammeter
	Hole core drill		Gas-leak detector
	Spanner		Thermometer, Level
	Torque wrench		Flaring tool set

INSTALLATION OF OUTDOOR UNIT

You need to select adequate installation location considering the following conditions, and make sure to acquire the consent of the user.

Installation Places

- If an awning is built over the unit to prevent direct sunlight or rain exposure, make sure that heat radiation from the condenser is not restricted.
- Ensure that the spaces indicated by arrows around front, back and side of the unit are respected.
- Do not place animals and plants in the path of the warm air.
- Take the air conditioner weight into account and select a place where noise and vibration are minimum.
- Select a place so that the warm air and noise from the air conditioner do not disturb neighbors.
- Select a place that can sufficiently endure the weight and vibration of the outdoor unit and where even installation is possible.
- Select a place that has no direct impact of snow or rain
- Select a place with no danger of snowfall or icicle drop
- Select a place without weak floor or base such as decrepit part of the building or with a lot of snow accumulation
- Install at a place with fluent water draining to prevent damage from localized heavy rain and avoid frequent flooded area.

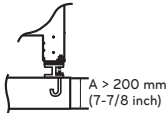
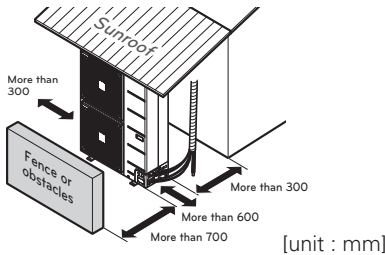

! CAUTION

Be very careful while carrying the product.

- Do not have only one person carry product if it is more than 20 kg.
- PP bands are used to pack some products. Do not use them as a mean for transportation because they are dangerous.
- Do not touch heat exchanger fins with your bare hands. Otherwise you may get a cut in your hands.
- Tear plastic packaging bag and scrap it so that children cannot play with it. Otherwise plastic packaging bag may suffocate children to death.
- When carrying in Outdoor Unit, be sure to support it at four points. Carrying in and lifting with 3-point support may make Outdoor Unit unstable, resulting in a fall.
- Use 2 belts of at least 8 m long.
- Place extra cloth or boards in the locations where the casing comes in contact with the sling to prevent damage.
- Hoist the unit making sure it is being lifted at its center of gravity.

Piping length and the elevation

- Single Operation

1) Standard Inverter / High Inverter

ODU	Capacity (kBtu/h)	Pipe Size mm(inch)		Length A(m)		Elevation B(m)		Additona refrigerant (g/m)
		Gas	Liquid	Standard	Max	Standard	Max	
UUA1	9/12	∅ 9.52 (3/8)	∅ 6.35 (1/4)	7.5	20	5	15	20
UUB1	18	∅ 12.7(1/2)	∅ 6.35 (1/4)	7.5	30	5	30	20
UUC1	24/30	∅ 15.88 (5/8)	∅ 9.52 (3/8)	7.5	50	5	30	40
UUD1/UUD3	36/42/48/60	∅ 15.88 (5/8)	∅ 9.52 (3/8)	7.5	85	5	30	40

2) Compact Inverter

ODU	Capacity (kBtu/h)	Pipe Size mm(inch)		Length A(m)		Elevation B(m)		Additona refrigerant (g/m)	Connector Type
		Gas	Liquid	Standard	Max	Standard	Max		
UUA1	18	∅ 12.7 (1/2)	∅ 6.35 (1/4)	7.5	30	5	30	20	b
UUB1	24/30	∅ 15.88 (5/8)	∅ 9.52 (3/8)	7.5	35	5	30	40	a, c
UUC1	36	∅ 15.88 (5/8)	∅ 9.52 (3/8)	7.5	50	5	30	40	-

* Connector information

Connector		a	b	c
		∅ 6.35 → ∅ 9.52	∅ 9.52 → ∅ 12.7	∅ 12.7 → ∅ 15.88
UUA1	**09F	X	X	X
	**12F	X	X	X
	**18F	X	O	X
UUB1	**18F	X	X	X
	**24F	O	X	O
	**30F	O	X	O

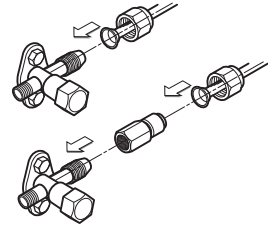

ex.) UUA1 + CT18F

If installed tube is shorter than 7.5 m, additional charging is not necessary.

Additional Refrigerant

= [A-7.5 (m)] x Additional refrigerant (g/m)

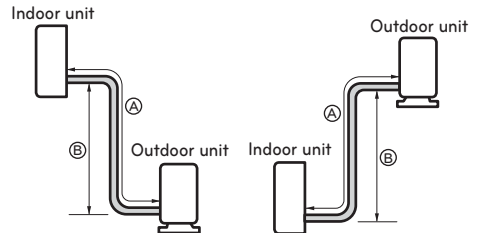

Minimum floor area(for R32)

- The appliance shall be installed, operated and stored in a room with a floor area larger than the minimum area.
- Use the graph of table to determine the minimum area.

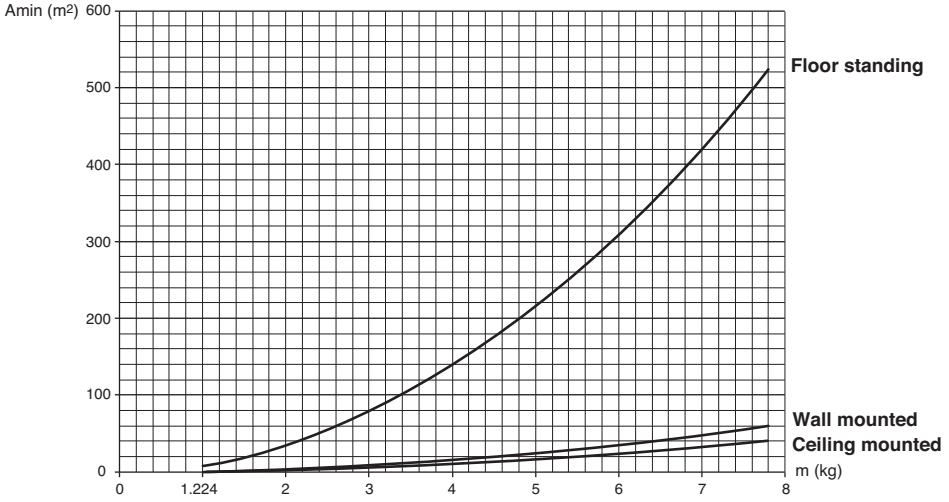

- m : Total refrigerant amount in the system
- Total refrigerant amount : factory refrigerant charge + additional refrigerant amount
- Amin : minimum area for installation

Floor location	
m (kg)	Amin (m ²)
< 1.224	-
1.224	12.9
1.4	16.82
1.6	21.97
1.8	27.80
2	34.32
2.2	41.53
2.4	49.42
2.6	58.00
2.8	67.27
3	77.22
3.2	87.86
3.4	99.19
3.6	111.20
3.8	123.90
4	137.29
4.2	151.36
4.4	166.12

Floor location	
m (kg)	Amin (m ²)
4.6	181.56
4.8	197.70
5	214.51
5.2	232.02
5.4	250.21
5.6	269.09
5.8	288.65
6	308.90
6.2	329.84
6.4	351.46
6.6	373.77
6.8	396.76
7	420.45
7.2	444.81
7.4	469.87
7.6	495.61
7.8	522.04

Wall mounted	
m (kg)	Amin (m ²)
< 1.224	-
1.224	1.43
1.4	1.87
1.6	2.44
1.8	3.09
2	3.81
2.2	4.61
2.4	5.49
2.6	6.44
2.8	7.47
3	8.58
3.2	9.76
3.4	11.02
3.6	12.36
3.8	13.77
4	15.25
4.2	16.82
4.4	18.46

Wall mounted	
m (kg)	Amin (m ²)
4.6	20.17
4.8	21.97
5	23.83
5.2	25.78
5.4	27.80
5.6	29.90
5.8	32.07
6	34.32
6.2	36.65
6.4	39.05
6.6	41.53
6.8	44.08
7	46.72
7.2	49.42
7.4	52.21
7.6	55.07
7.8	58.00

Ceiling Mounted	
m (kg)	Amin (m ²)
< 1.224	-
1.224	0.956
1.4	1.25
1.6	1.63
1.8	2.07
2	2.55
2.2	3.09
2.4	3.68
2.6	4.31
2.8	5.00
3	5.74
3.2	6.54
3.4	7.38
3.6	8.27
3.8	9.22
4	10.21
4.2	11.26
4.4	12.36

Ceiling Mounted	
m (kg)	Amin (m ²)
4.6	13.50
4.8	14.70
5	15.96
5.2	17.26
5.4	18.61
5.6	20.01
5.8	21.47
6	22.98
6.2	24.53
6.4	26.14
6.6	27.80
6.8	29.51
7	31.27
7.2	33.09
7.4	34.95
7.6	36.86
7.8	38.83

18 INSTALLATION OF OUTDOOR UNIT

• Synchro Operation

Install the branch pipe so that pipe length and difference between high and low will not exceed below Spec.

[Unit : m]

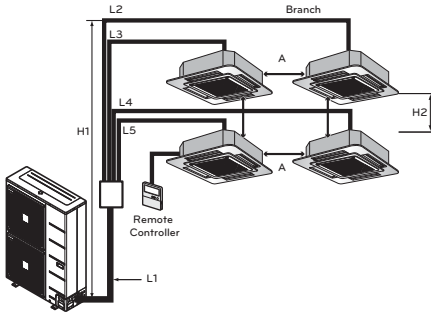

Pipe Length & Height	Spec(MAX.)
Total(L1+L2+L3+L4+L5)	80
Main Pipe(L1)	45
Branch Pipe (L2+L3+L4+L5)	40
Each	15
Indoor-Outdoor (H1)	30
Indoor-Indoor (H2)	1
(L1+L2),(L1+L3),(L1+L4),(L1+L5)	70
A	10

- When installing the branch pipe, direction and angle of installation is not limited.
- Take care so that burrs and foreign material may not enter into the cutting surface when connecting.
- Connect remaining those by cutting or direct insertion to the diameter of pipe.

• Refrigerant Additional Charging Method

For additional charging method, see below table.

Indoor Unit	Refrigerant Additional charging (g)	Pipe Diameter. (mm)	C (g/m)
Duo	Refrigerant = (L1-b) x B + (L2 + L3) x C	Ø 6.35	35
Trio	Refrigerant = (L1-b) x B + (L2 + L3 + L4) x C		
Quartet	Refrigerant = (L1-b) x B + (L2 + L3 + L4 + L5) x C	Ø 9.52	40

Model	b(m)	B(g/m)
UUD1 / UUD3	7.5	40

NOTE

- b : Rated performance for refrigerant line length.
- C : Additional charging Refrigerant of Branch Liquid Pipe.
- B : Additional charging Refrigerant of Main Liquid Pipe.

CAUTION

- Capacity is based on standard length and maximum allowance length is on the basis of reliability.
- Improper refrigerant charge may result in abnormal cycle.

Synchro Combination table

		Possible combination of indoor units					
		Synchro					
		Duo		Trio		Quartet	
IDU : INDOOR UNIT ODU : OUTDOOR UNIT BD : BRANACH DISTRIBUTOR UNIT REMO : WIRED REMOTE CONTROLLER							
MODEL		Cassette	Duct	Cassette	Duct	Cassette	Duct
UUD1 / UUD3		CT18F * 2	CM18F * 2	CT12F * 3	CL12F * 3	CT12F * 4	CL12F * 4
		CT24F * 2	CM24F * 2	CT18F * 3	CM18F * 3		
		UT30F * 2	UM30F * 2				
Applied Accessories	BD unit	PMUB11A		PMUB111A		PMUB1111A	
	Simple central controller**	PQCSZ250S0					

NOTE

** When using synchro operation,

- Do not use wireless remote controller.
- Use only one wired remote controller in the indoor units.
- Use central controller and function controller "PQCSZ250S0" only.

Outdoor Unit PCB Setting Procedure For Simultaneous Operation System

1 DIP_SW Setting

Set the DIP_SW as below Table (A)

2 Auto Addressing Method

Addressing work assigns address to each indoor unit. When firstly installing product or replacing the indoor unit PCB. Auto Addressing work should be done for simultaneous operation.

* Work procedure

1) Set DIP_SW correctly.

2) Turn on main power.

3) Press the SW01M for about 3 seconds within 3 minutes After main power on.(B)

4) After step 3), the LED01E(red LED) and LED02E(green LED) rapidly flickers. When Addressing work is done, green LED is off, else LED (LED01E) stops flickering and lights continuously. Address of indoor unit is indicated on the wired remote control display window. (CH01, CH02, CH03, CH04)

5) Press (⏻) button to turn on the indoor.

6) If you fail to perform the Addressing work, repeat step 2)~5).

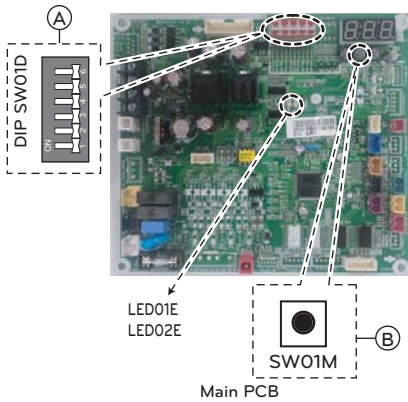

DIP SW01D	Indoor Unit No.
	1(Single) : Default
	2(Duo)
	3(Trio)
	4(Quartet)

CONNECTING PIPES

Preparation of Piping

- Main cause of gas leakage is defect in flaring work. Carry out correct flaring work in the following procedure.
- Use the de-oxidised copper as piping materials to install.

Cut the pipes and the cable.

- Use the accessory piping kit or the pipes purchased locally.
- Measure the distance between the indoor and the outdoor unit.
- Cut the pipes a little longer than measured distance.
- Cut the cable 1.5 m longer than the pipe length.

Burrs removal

- Completely remove all burrs from the cut cross section of pipe/tube.
- Put the end of the copper tube/pipe to downward direction as you remove burrs in order to avoid to let burrs drop in the tubing.

Putting nut on

- Remove flare nuts attached to indoor and outdoor units, than put them on pipe/tube having completed burr removal. (Not possible to put them on after flaring work)

Flaring work

- Carry out flaring work using dedicated flaring tool for R32 as shown below.

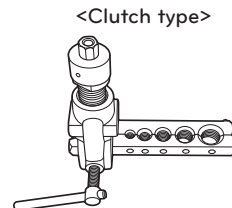
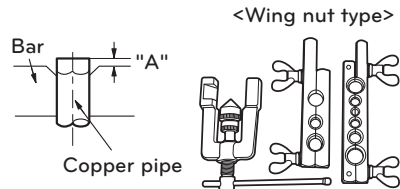
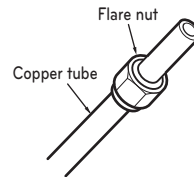
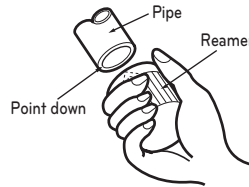
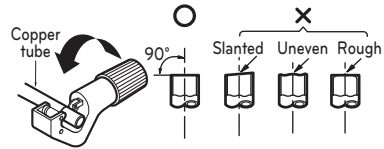

Pipe diameter inch (mm)	A inch (mm)	
	Wing nut type	Clutch type
Ø 1/4 (Ø 6.35)	0.04~0.05 (1.1~1.3)	0~0.02 (0~0.5)
Ø 3/8 (Ø 9.52)	0.06~0.07 (1.5~1.7)	
Ø 1/2 (Ø 12.7)	0.06~0.07 (1.6~1.8)	
Ø 5/8 (Ø 15.88)	0.06~0.07 (1.6~1.8)	
Ø 3/4 (Ø 19.05)	0.07~0.08 (1.9~2.1)	

Firmly hold copper tube in a bar(or clamp) as indicated dimension in the table above.

Check

- Compare the flared work with figure below.
- If flare is noted to be defective, cut off the flared section and do flaring work again.

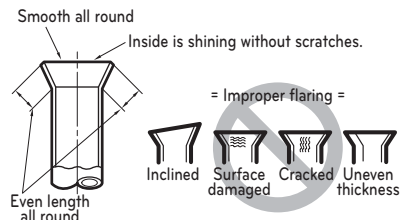

Connection of piping - Outdoor

- Align the center of the piping and sufficiently tighten the flare nut by hand.
- Finally, tighten the flare nut with torque wrench until the wrench clicks. When tightening the flare nut with torque wrench ensure the direction for tightening follows the arrow on the wrench.

Outside diameter		Torque kg·m
mm	inch	
Ø 6.35	1/4	1.8~2.5
Ø 9.52	3/8	3.4~4.2
Ø 12.7	1/2	5.5~6.6
Ø 15.88	5/8	6.6~8.2

- * When tighten the pipe, hold the hexagonal body.

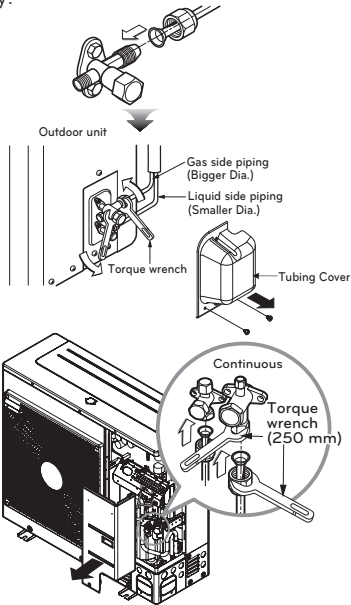

Preventing foreign objects from entering (Figure 2)

- Plug the pipe through-holes with putty or insulation material (procured locally) to stop up all gaps, as shown in the figure 2.

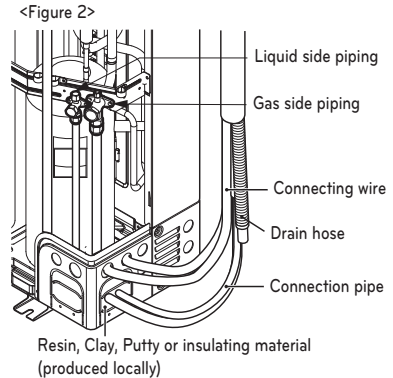

CAUTION

Insects or small animals entering the outdoor unit may cause a short circuit in the electrical box.

CAUTION

- A brazed, welded, or mechanical connection shall be made before opening the valves to permit refrigerant to flow between the refrigerating system parts.
- When flared joints are reused indoors, the flare part shall be re-fabricated. (for R32)
- When mechanical connectors are reused indoors, sealing parts shall be renewed. (for R32)
- Copper in contact with refrigerants shall be oxygen-free or deoxidized, for example Cu-DHP as specified in EN 12735-1 and EN 12735-2.

Forming the piping

Form the piping by wrapping the connecting portion of the indoor unit with insulation material and secure it with two kinds of vinyl tape.

- If you want to connect an additional drain hose, the end of the drain outlet should be routed above the ground. Secure the drain hose appropriately.

In cases where the outdoor unit is installed below the indoor unit perform the following.

- 1 Tape the piping, drain hose and connecting cable from down to up.
- 2 Secure the tapped piping along the exterior wall using saddle or equivalent.

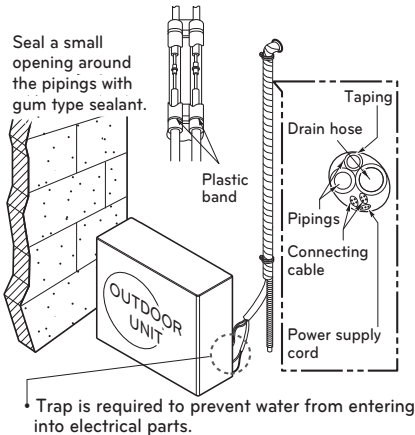

In cases where the Outdoor unit is installed above the Indoor unit perform the following.

- 1 Tape the piping and connecting cable from down to up.
- 2 Secure the taped piping along the exterior wall. Form a trap to prevent water entering the room.
- 3 Fix the piping onto the wall by saddle or equivalent.

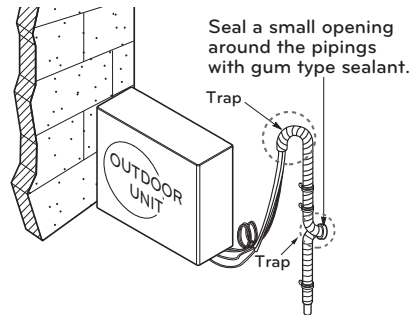

CAUTION

- Refrigerant tubing shall be protected or enclosed to avoid damage.
- Flexible refrigerant connectors (such as connecting lines between the indoor and outdoor unit) that may be displaced during normal operations shall be protected against mechanical damage.

WIRING CONNECTION

Electrical Wiring

Perform the electrical wiring work according to the electrical wiring connection.

- All wiring must comply with local requirements.
- Select a power source that is capable of supplying the current required by the air conditioner.
- Use a recognized ELCB(Electric Leakage Circuit Breaker) between the power source and the unit. A disconnection device to adequately disconnect all supply lines must be fitted.
- Model of circuit breaker recommended by authorized personnel only

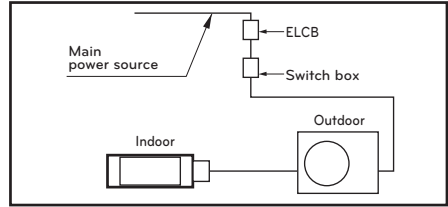

Model Name	Phase(Ø)	ELCB (A)
UUA1	1	15
UUB1	1	20
UUC1	1	25
UUD1	1	40
UUD3	3	20

Connecting Cables between Indoor Unit and Outdoor Unit

- Connect the wires to the terminals on the control board individually according to the outdoor unit connection.
- Ensure that the color of the wires of outdoor unit and the terminal No. are the same as those of indoor unit respectively

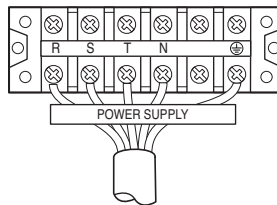
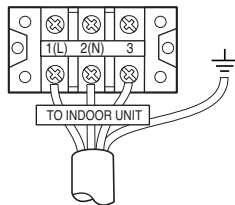
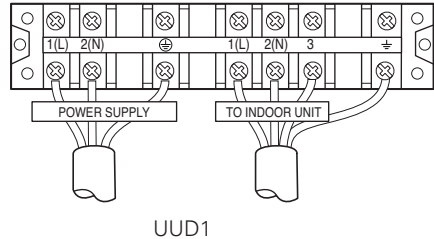
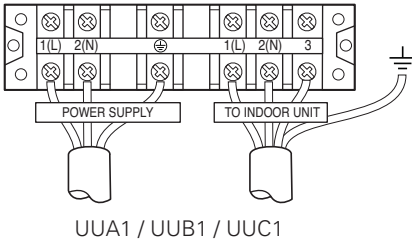

UUD3

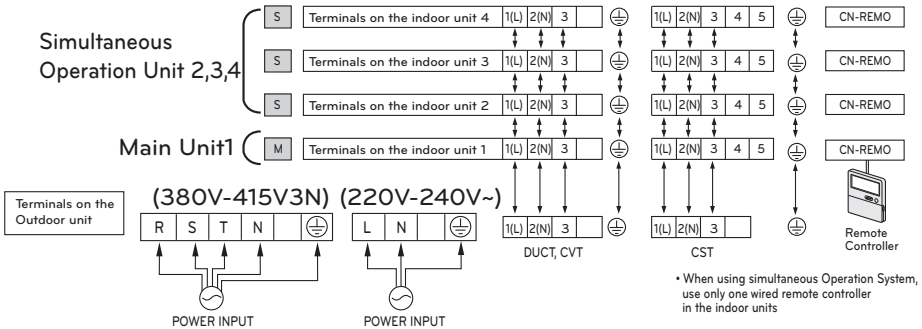

CAUTION

The power cord connected to the outdoor unit should comply to IEC 60245 or HD 22.4 S4 (This equipment shall be provided with a cord set complying with the national regulation.)

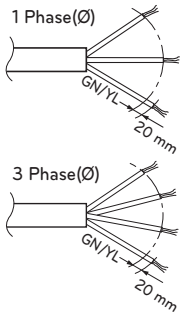

NORMAL CROSS-SECTIONAL AREA

Model Name	Phase(Ø)	Area(mm ²)
UUA1 / UUB1 / UUC1	1	2.5
UUD1	1	6
UUD3	3	2.5

The connecting cable connected to the outdoor unit should comply to IEC 60245 or HD 22.4 S4 (This equipment shall be provided with a cord set complying with the national regulation.)

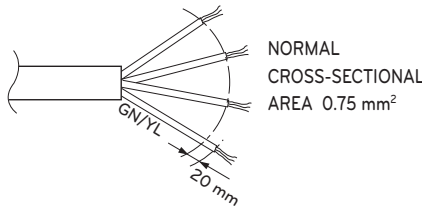

When the connection line between the indoor unit and outdoor unit is over 40 m, connect the telecommunication line and power line separately.

If the supply cord is damaged, it must be replaced by a special cord or assembly available from the manufacturer of its service agent.

Pipes and wires should be purchased separately for installation of the product.

Precautions when laying power wiring

Use round pressure terminals for connections to the power terminal block.



When none are available, follow the instructions below.

- Do not connect wiring of different thicknesses to the power terminal block. (Slack in the power wiring may cause abnormal heat.)
- When connecting wiring which is the same thickness, do as shown in the figure below.

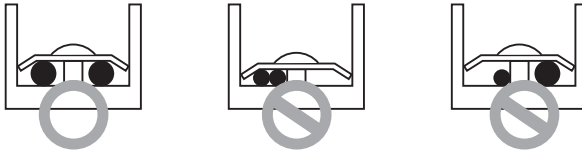

WARNING

Make sure that the screws of the terminal are free from looseness.

Connecting the cable to Outdoor Unit

Remove the side panel for wiring connection.

Use the cord clamp to fix the cord.

Earthing work

- Case 1 : Terminal block of Outdoor Unit have \oplus mark.

Connect the cable of diameter 1.6 mm² or more to the earthing terminal provided in the control box and do earthing.

- Case 2 : Terminal block of Outdoor Unit don't have \oplus mark.

Connect the cable of diameter 1.6 mm² or more, to the panel of control box, marked as \oplus and fasten with earth screw

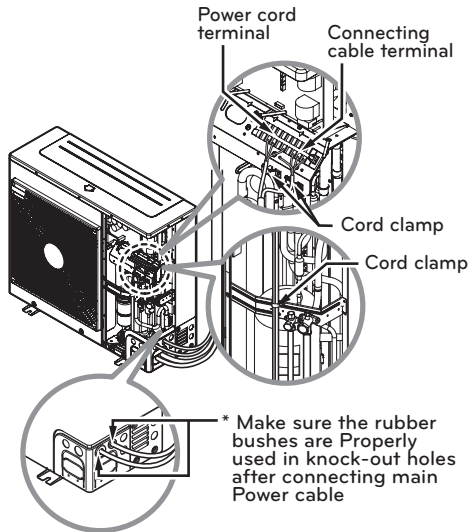

⚠ CAUTION

- The circuit diagram is not subject to change without notice.
- Be sure to connect wires according to the wiring diagram.
- Connect the wires firmly, so that They won't be pulled out easily.
- Connect the wires according to color codes by referring the wiring diagram.
- The Power cord connected to the unit should be selected according to the specifications on 24 page.

LEAKAGE TEST AND EVACUATION

Air and moisture remaining in the refrigerant system have undesirable effects as indicated below.

- Pressure in the system rises.
- Operating current rises.
- Cooling (or heating) efficiency drops.
- Moisture in the refrigerant circuit may freeze and block capillary tubing.
- Water may lead to corrosion of parts in the refrigeration system.

Therefore, the indoor/outdoor unit and connecting tube must be checked for leak tight, and vacuumed to remove incondensable gas and moisture in the system.

Preparation

- Check that each tube (both liquid and gas side tubes) between the indoor and outdoor units have been properly connected and all wiring for the test run have been completed. Remove the service valve caps from both the gas and the liquid side on the outdoor unit. Check that both the liquid and the gas side service valves on the outdoor unit are kept closed at this stage.

Leakage test

- Connect the manifold valve (with pressure gauges) and dry nitrogen gas cylinder to this service port with charge hoses.



CAUTION

Be sure to use a manifold valve for leakage test. If it is not available, use a stop valve for this purpose. The "Hi" knob of the manifold valve must always be kept close.

- Pressurize the system to no more than 3.8 MPa with dry nitrogen gas and close the cylinder valve when the gauge reading reached 3.8 MPa Next, test for leaks using bubble test solution.



CAUTION

To avoid nitrogen entering the refrigerant system in a liquid state, the top of the cylinder must be higher than its bottom when you pressurize the system. Usually, the cylinder is used in a vertical standing position.

- 1 Do a leakage test of all joints of the tubing (both Indoor unit and outdoor unit) and both gas and liquid side service valves. Bubbles indicate a leak. Be sure to wipe off the soap with a clean cloth.
- 2 After the system is found to be free of leaks, relieve the nitrogen pressure by loosening the charge hose connector at the nitrogen cylinder. When the system pressure is reduced to normal, disconnect the hose from the cylinder.

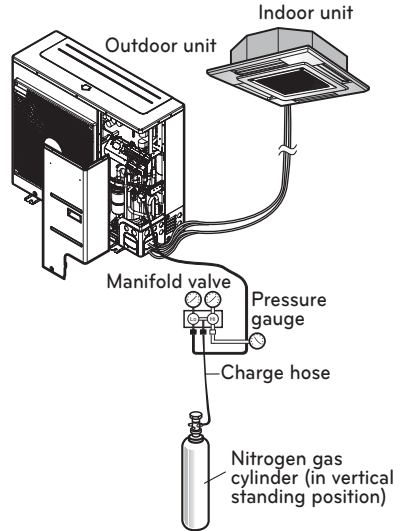

Evacuation

- Connect the charge hose end described in the preceding steps to the vacuum pump to evacuate the tubing and indoor unit. Confirm the "Lo and Hi" knob of the manifold valve is open. Then, run the vacuum pump. The operation time for evacuation varies with tubing length and capacity of the pump. The following table shows the time required for evacuation.
- When the desired vacuum is reached, close the "Lo and Hi" knob of the manifold valve and stop the vacuum pump.

Required time for evacuation when 11.36 l/h vacuum pump is used	
If tubing length is less than 10 m (33 ft)	If tubing length is longer than 10 m (33 ft)
30 min. or more	60 min. or more
0.07 kPa or less	

Finishing the job

- With a service valve wrench, turn the valve stem of liquid side valve counter-clockwise to fully open the valve.
- Turn the valve stem of gas side valve counter-clockwise to fully open the valve.
- Loosen the charge hose connected to the gas side service port slightly to release the pressure, then remove the hose.
- Replace the flare nut and its bonnet on the gas side service port and fasten the flare nut securely with an adjustable wrench. This process is very important to prevent leakage from the system.
- Replace the valve caps at both gas and liquid side service valves and fasten them tight.

This completes air purging with a vacuum pump.

The air conditioner is now ready to test run.

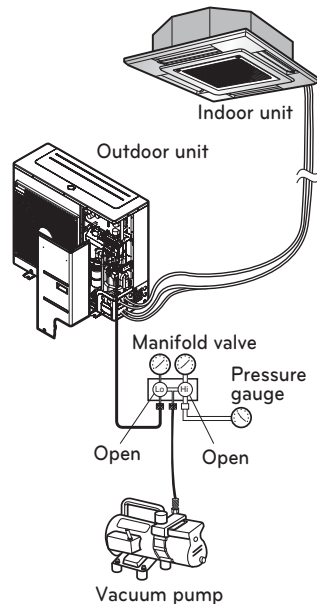

TEST RUNNING

1 Precautions In Test Running

- The initial power supply must provide at least 90 % of the rated voltage. Otherwise, the air conditioner should not be operated.

CAUTION

- For test run, carry out the cooling operation firstly even during heating season. If heating operation is carried out firstly, it leads to the trouble of compressor. Then attention must be paid.
- Carry out the test run more than 5 minutes without fail. (Test run will be cancelled 18 minutes later automatically)

- The test run is started by pressing the room temperature checking button and down timer button for 3 seconds at the same time.
- To cancel the test run, press any button.

CHECK THE FOLLOWING ITEMS WHEN INSTALLATION IS COMPLETE

- After completing work, be sure to measure and record trial run properties, and store measured data, etc.
- Measuring items are room temperature, outside temperature, suction temperature, blow out temperature, wind velocity, wind volume, voltage, current, presence of abnormal vibration and noise, operating pressure, piping temperature, compressive pressure.
- As to the structure and appearance, check following items.

- Is the circulation of air adequate?
- Is the draining smooth?
- Is the heat insulation complete (refrigerant and drain piping)?
- Is there any leakage of refrigerant?

- Is the remote controller switch operated?
- Is there any faulty wiring?
- Are not terminal screws loosened?

M4.....118 N-cm{12 kgf-cm}

M5.....196 N-cm{20 kgf-cm}

M6.....245 N-cm{25 kgf-cm}

M8.....588 N-cm{60 kgf-cm}

2 Connection of power supply

- Connect the power supply cord to the independent power supply. Circuit breaker is required.
- Operate the unit for fifteen minutes or more.

3 Evaluation of the performance

- Measure the temperature of the intake and discharge air.
- Ensure the difference between the intake temperature and the discharge one is more than 8 °C (Cooling) or reversely (Heating).

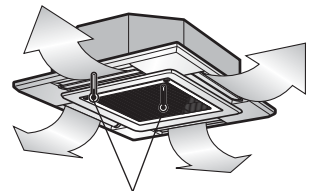

Thermometer

! CAUTION

After the confirmation of the above conditions, prepare the wiring as follows:

- 1 Never fail to have an individual power specialized for the air conditioner. As for the method of wiring, be guided by the circuit diagram pasted on the inside of control box cover.
- 2 Provide a circuit breaker switch between power source and the unit.
- 3 The screw which fasten the wiring in the casing of electrical fittings are liable to come loose from vibrations to which the unit is subjected during the course of transportation. Check them and make sure that they are all tightly fastened. (If they are loose, it could give rise to burn-out of the wires.)
- 4 Specification of power source
- 5 Confirm that electrical capacity is sufficient.
- 6 Be sure that the starting voltage is maintained at more than 90 percent of the rated voltage marked on the name plate.
- 7 Confirm that the cable thickness is as specified in the power sources specification. (Particularly note the relation between cable length and thickness.)
- 8 Never fail to equip a leakage breaker where it is wet or moist.
- 9 The following troubles would be caused by voltage drop-down.
 - Vibration of a magnetic switch, damage on the contact point there of fuse breaking, disturbance to the normal function of a overload protection device.
 - Proper starting power is not given to the compressor.
- 10 Use only 1 remote-controller contained in indoor unit, when using simultaneous operation system as shown below.
After setting the ESP value in the Ceiling Concealed Duct Type Indoor Unit, the main power turns off and then remove the remote controller.
- 11 It is possible to connect (install) same type of indoor units only and also with in a single room.
- 12 Connecting cable length is up to 90 m.

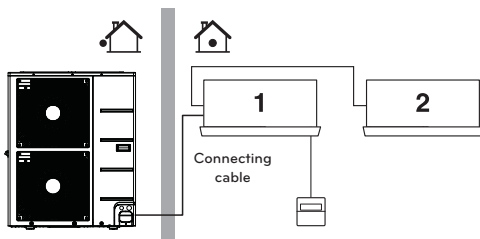

HAND OVER

Teach the customer the operation and maintenance procedures, using the operation manual (air filter cleaning, temperature control, etc.).

INSTALLATION PI485

Fix the PI485 PCB as shown in below images.

For detailed installation method refer to PI485 Installation Manual.

UUA1

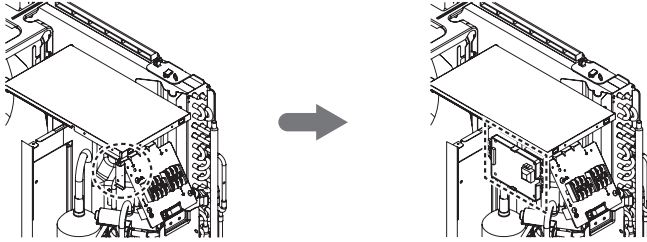

UUB1

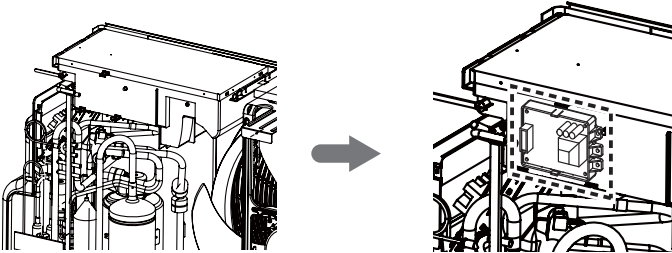

UUC1

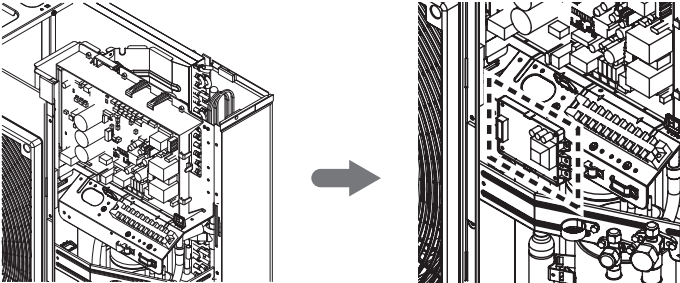

UUD1 / UUD3

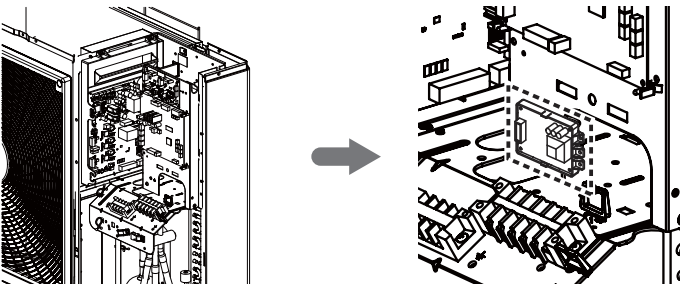

FUNCTION



DIP S/W Setting

If you set the DIP Switch when power is on, the change in setting is not applicable. The changing setting is enabled only when Power is reset.

DIP Switch		Function
1	2	
		Normal Operation (No Function)
		Pump Down
		Saving Power Consumption (Step 1)
		Saving Power Consumption (Step 2)
		Mode Lock (Cooling)
		Mode Lock (Heating)
		Night Quiet Mode (Step 1)
		Night Quiet Mode (Step 2)
		Mode Lock (Cooling) + Night Quiet Mode (Step 1)
		Mode Lock (Cooling) + Night Quiet Mode (Step 2)
		Mode Lock (Cooling) + Saving Power Consumption (Step 1)
		Mode Lock (Cooling) + Saving Power Consumption (Step 2)
		Mode Lock (Heating) + Saving Power Consumption (Step 1)
		Mode Lock (Heating) + Saving Power Consumption (Step 2)

1 : UUB1 / UUC1

2 : UUD1 / UUD3

DIP Switch	Function
1 2 3 4 5 6	
	Synchro_Duo
	Synchro_Trio
	Synchro_Quartet

! WARNING

When you set the DIP switch, you should turn off the circuit breaker or shut the power source of the product down.

! CAUTION

- Unless the applicable DIP switch is set properly, the product may not work.
- If you want to set a specific function, request that the installer sets the DIP switch appropriately during installation.

Pump Down

Setting Procedure

- 1 Set the DIP Switch as follow after shutting the power source down.

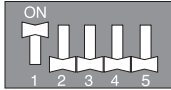

UUB1 / UUC1

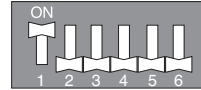

UUD1 / UUD3

- 2 Reset the power.
- 3 Red LED and Green LED of PCB lights during work.
(The indoor unit is operated by force.)
- 4 If operation is done, Red LED will be turned off.
If operation is not done normally, Red LED will blink.
- 5 Close the Liquid valve only after green LED turned off (7 minutes from the start of the machine). Then close the gas valve after Green LED on.

! WARNING

- When the green LED of PCB is on, compressor is going to be off because of low pressure.
- You should return the DIP Switch to operate normally after finishing the operation.
- Improper Pump down will lead to product turn off along with LED (green & red) off with in 20 minutes from the initial start.

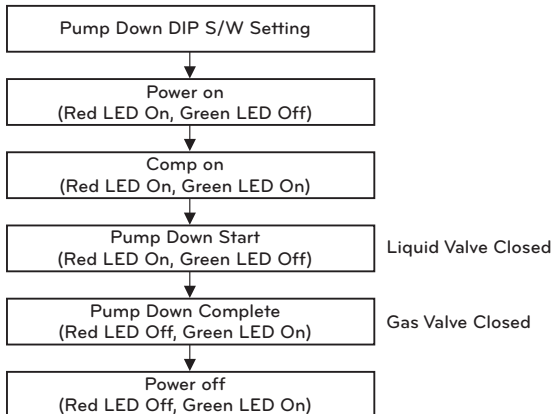

- The actual product can be different from above contents depending upon model type.

Saving Power Consumption

Saving Power Consumption operation is the function which enables efficient operation by lowering the maximum power consumption value.

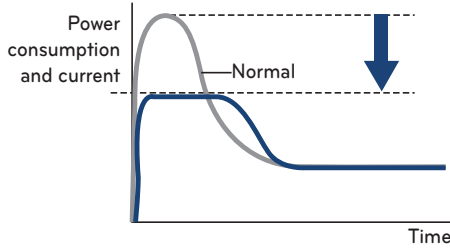

Setting Procedure

1 Set the DIP Switch as follow after shutting the power source down.

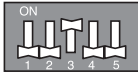

UUB1 / UUC1



UUB1 / UUC1



UUD1 / UUD3

Step 1



UUD1 / UUD3

Step 2

2 Reset the power.

Saving Power Consumption with Mode Lock.



UUB1 / UUC1

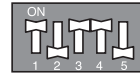

UUB1 / UUC1



UUD1 / UUD3



UUD1 / UUD3

Saving Power Consumption (step 1)
+ Mode Lock (Cooling)

Saving Power Consumption (step 1)
+ Mode Lock (Heating)



UUB1 / UUC1

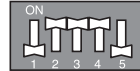

UUB1 / UUC1



UUD1 / UUD3



UUD1 / UUD3

Saving Power Consumption (step 2)
+ Mode Lock (Cooling)

Saving Power Consumption (step 2)
+ Mode Lock (Heating)

Night Quiet Mode

Night Quiet Mode operation lowers the noise level of the outdoor unit by changing the Compressor's frequency and fan speed. This function is operated all night long.

Setting Procedure

1 Set the DIP Switch as follow after shutting the power source down.

* Noise level : Step 1 > Step 2

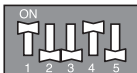

UUB1 / UUC1

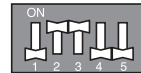

UUB1 / UUC1



UUD1 / UUD3



UUD1 / UUD3

Step 1

Step 2

2 Reset the power.

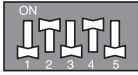
Night Quiet Mode with Mode Lock.

UUB1 / UUC1

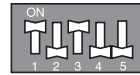

UUB1 / UUC1

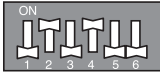

UUD1 / UUD3



UUD1 / UUD3

Mode Lock (Cooling)
+ Night Quiet Mode (step 1)

Mode Lock (Cooling)
+ Night Quiet Mode (step 2)

CAUTION

- If compressor's frequency and fan speed are down, the cooling capacity may decrease accordingly.
- This function is only available for Cooling Mode.
- If you want to stop the Night Quiet Mode, Change the DIP Switch.
- If operating indoor unit is set by the fan speed "Power", Night Quiet Mode will be stopped until fan speed "Power" is changed.

Mode Lock

Setting Procedure

- 1 Set the DIP Switch as follow after shutting the power source down.

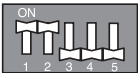

UUB1 / UUC1

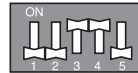

UUB1 / UUC1



UUD1 / UUD3

Only Cooling Mode

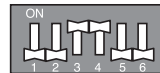

UUD1 / UUD3

Only Heating Mode

- 2 Reset the power.

Mode Lock with Night Quiet Mode

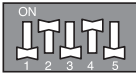

UUB1 / UUC1

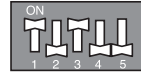

UUB1 / UUC1

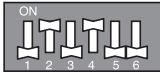

UUD1 / UUD3



UUD1 / UUD3

Mode Lock (Cooling)
+ Night Quiet Mode (step 1)

Mode Lock (Cooling)
+ Night Quiet Mode (step 2)

Saving Power Consumption with Mode Lock.

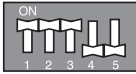

UUB1 / UUC1



UUB1 / UUC1

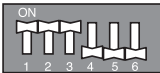

UUD1 / UUD3



UUD1 / UUD3

Mode Lock (Cooling) + Saving Power
Consumption (step 1)

Mode Lock (Heating) + Saving Power
Consumption (step 1)



UUB1 / UUC1



UUB1 / UUC1



UUD1 / UUD3



UUD1 / UUD3

Mode Lock (Cooling) + Saving Power
Consumption (step 2)

Mode Lock (Heating) + Saving Power
Consumption (step 2)

INSTALLATION GUIDE AT THE SEASIDE

⚠ CAUTION

- Air conditioners should not be installed in areas where corrosive gases, such as acid or alkaline gas, are produced.
- Do not install the product where it could be exposed to sea wind (salty wind) directly. It can result corrosion on the product. Corrosion, particularly on the condenser and evaporator fins, could cause product malfunction or inefficient performance.
- If outdoor unit is installed close to the seaside, it should avoid direct exposure to the sea wind. Otherwise it needs additional anticorrosion treatment on the heat exchanger.

Selecting the location (Outdoor Unit)

In case, to install the outdoor unit on the seaside, set If the outdoor unit is to be installed close to the seaside, direct exposure to the sea wind should be avoided.

Install the outdoor unit on the opposite side of the sea wind direction. a windbreak not to be exposed to the sea wind.

In case, to install the outdoor unit on the seaside, set up a windbreak not to be exposed to the sea wind

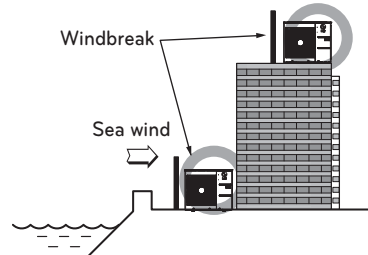

- It should be strong enough like concrete to prevent the sea wind from the sea.
- The height and width should be more than 150 % of the outdoor unit.
- More than 70 cm of space should be kept between outdoor unit and the windbreak for easy air flow.

Place with fluent water draining

- Install at a place with fluent water draining to prevent damage from localized heavy rain and avoid frequent flooded area.

- Periodic (more than once/year) cleaning of the dust or salt particles stuck on the heat exchanger by using water.

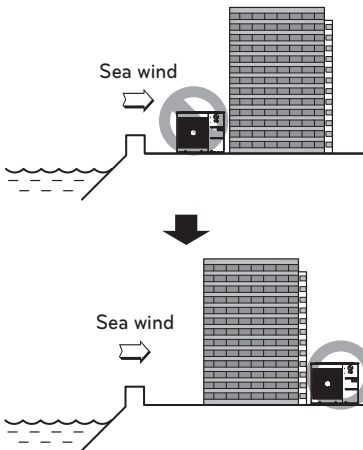

SEASONAL WIND AND CAUTIONS IN WINTER

- Sufficient measures are required in a snow area or severe cold area in winter so that product can operate well.
- Get ready for seasonal wind or snow in winter even in other areas.
- Install a suction and discharge duct not to let in snow or rain.
- Install the outdoor unit not to come in contact with snow directly. If snow piles up and freezes on the air suction hole, the system may malfunction. If it is installed at snowy area, attach the hood to the system.
- Install the outdoor unit at the higher installation console by 50 cm than the average snowfall (annual average snowfall) if it is installed at the area with much snowfall.
- Where snow accumulated on the upper part of the Outdoor Unit by more than 10 cm, always remove snow for operation.